



HSL Zuid

Phase II – Implementation Concept

Final Report

Study for alternative transport system on HSL Zuid

DB International GmbH

Central Germany and Western Europe

Oskar-Sommer-Straße 15

D-60596 Frankfurt / Main

04.06.2009

Executive Summary

As extension of Study Phase I (Desk Research) DB International (DBI) has been assigned by the Ministry of Transport (Verkeer en Waterstaat) to substantiate the proposed alternative solutions and to evaluate the current commissioning concept of ETCS. The results of this extended evaluation are reflected within this report (Study Phase II - Implementation Concept).

Whereas in Phase I DBI has had a different view upon the situation of HSL Zuid than in Phase II, the approach did fundamentally change. In fact the current commissioning concept is far more promising than the initial situation was when DBI has been assigned for Phase I.

- Situation Phase I: The commissioning of ETCS is far behind the schedule due to Rolling Stock problems. DBI has been assigned to elaborate alternatives under the condition that even within 5 years time ETCS will not be in operation for revenue service.
- Situation Phase II: The track side assembly of ETCS has been certified. Even the proposed loco for public passenger transport, BR 186 (Traxx) has been certified and holds an "Inzetcertificaat". Only minor issues have to be dealt with to commission the line.

Despite of this more optimistic estimation with regard to the HSL Zuid, DBI was asked to continue to investigate alternatives and drafted a concept for ATB-NG, PZB and "No-Control Command System" with evaluation of costs, time and implementation risks.

The results of Study Phase I can be confirmed here. If alternative solutions are required to mitigate risks of ETCS commissioning, PZB remains the preferred solution. ATB-NG would introduce at least equal risks than commissioning of ETCS Level 2.

However, DBI does even not recommend implementing PZB on HSL Zuid. PZB introduces the lowest efforts, costs, duration (implementation & commissioning) and risks for alternative solutions but in comparison to the current situation of ETCS commissioning it cannot be recommended as a serious alternative.

The current planning of HSL Zuid seems promising for the proposed Train / infrastructure combination. No major risks have been identified by DBI. But this is only applicable for the proposed combination as it has been tested, homologated and approved. For future updates of software, exhaustive testing and validation will be required in order to reduce the risks of deficiencies during operation.

ETCS Level 1 with 300 km/h also has to be seen as an introduction of new risks for the project. It seems that little modifications of the system are required to upgrade the system. However, the experience shows that each modification of the system requires new validation, safety analysis and approvals.

The main conclusion of DBI for Phase II can be drawn as follows:

HSL Zuid should continue their efforts to start public revenue service with ETCS Level 1 within a stable environment (dedicated train-track configuration).

Each configuration change of infrastructure and/or trains have to be accompanied by exhaustive testing before introduction.

Content	Page
1 INTRODUCTION	5
2 ETCS	8
3 ALTERNATIVE SIGNALING SOLUTION WITHOUT CC SYSTEM	26
4 ATB-NG	36
5 ALTERNATIVE SIGNALING WITH PZB AS CC SYSTEM	48
6 CONCLUSION.....	59
7 APPENDIX.....	60

Approval

Established	Approved
Frankfurt/M, 04.06.2009	Frankfurt/M, 04.06.2009
Alfred Heneka, DB International Ad Kloppenburg, Railinfra Solutions Stefan Bode, DB AG Werner Geier, DB AG	Berthold Krall Peter Schließmann
Organization: s. above	DB International

History

Version	Date	Author	Modifications
1.0	19.05.09	DBI Experts	Final Draft
1.1	22.05.09	DBI Experts	Final Draft with corrections
2.0	04.06.09	DBI Experts	Final Report

1 Introduction

The technical boundaries and chances for integrating an alternative system on HSL Zuid or to adapt the current ETCS system have been analyzed and prioritized by various criteria in Phase I (Desk Research). This study (Phase II - implementation concept) evaluates the implementation of the proposed solutions on basis of specific project information that has been provided by HSL Zuid. The experts of DB International (DBI) did not have sufficient insight in the system configuration of HSL Zuid during Phase I. Therefore several assumptions that have been made in Phase I, have been analyzed on basis of specific project documentation in Phase II.

Explicitly for ATB-NG, PZB and No-CCS (alternative solution to operate without active CCS-system) implementation concepts have been analyzed and described in the particular chapters. Furthermore the modification of the ETCS Level 1 to enable operation with maximum speed has been assessed. These systems are alternative solutions to the current ETCS system.

Concerning ETCS DBI did extend the reflections of Phase I on basis of more detailed information of the current ETCS system design, the homologation and certification status and the presented commissioning concept of HSL Zuid (during Kick-Off Session 09.04.09 in Utrecht). Hence DBI does provide a second expert opinion to report upon potential risks and chances for the commissioning and operation of HSL Zuid under ETCS.

The following experts have been involved to elaborate the study:

Project management / co-ordination:	Mr. Dirk Ziegler, Mr. Peter Schließmann
No-CCS, PZB:	Mr. Alfred Heneka, Mr. Rene Zagrodnik
ATB-NG:	Mr. Ad Kloppenburg
ERTMS:	Mr. Stefan Bode
Rolling Stock:	Mr. Werner Geier, Mr. Martin Stapff

1.1 Starting point

Besides the results of the study Phase I DBI has taken the current commissioning concept of HSL Zuid / ProRail into account for the study Phase II. A Kick-Off meeting has been conducted 09.04.09 by participation of representatives of HSL Zuid, ProRail and DB International. During this meeting DBI has been informed about the current status of HSL Zuid which is described in this chapter.

According to statements of HSL Zuid, the technical conditions to start commercial operation are nearly fulfilled. Both infrastructure and Rolling Stock is apparently that far in certification, homologation and testing that the transport system is ready for commissioning to be operated as an integrated railway. The information as given to DBI reflects the status of march 2009.

DBI relies on the provided documentation and information of HSL Zuid. Consequently DBI did not assess whether the Notified Body (NoBo) or the National Safety Authority (NSA) have been taken sufficient care of the certification process. The focus of the study is on the current status and the commissioning concept and to check these against potential risks.

1.1.1 Commissioning Concept HSL Zuid

The commissioning of HSL Zuid is divided into phases by location (section North / South), train category (Thalys / TRAXX, BR186) and ETCS operation (Level 1 / Level 2).

The assessment of DBI is based upon the following scenario as presented by HSL Zuid to DBI: Start of commercial operation in August 09 on North section with passenger transport between Amsterdam and Rotterdam with the BR 186 (Traxx) under ETCS Level 1. For the time being, no specific plans exist to operate BR 186 on South section.

The Thalys will start commercial operation in December 09 (ETCS L1 on North / L2 on South).

The buffers are incorporated to capture potential commissioning risks.

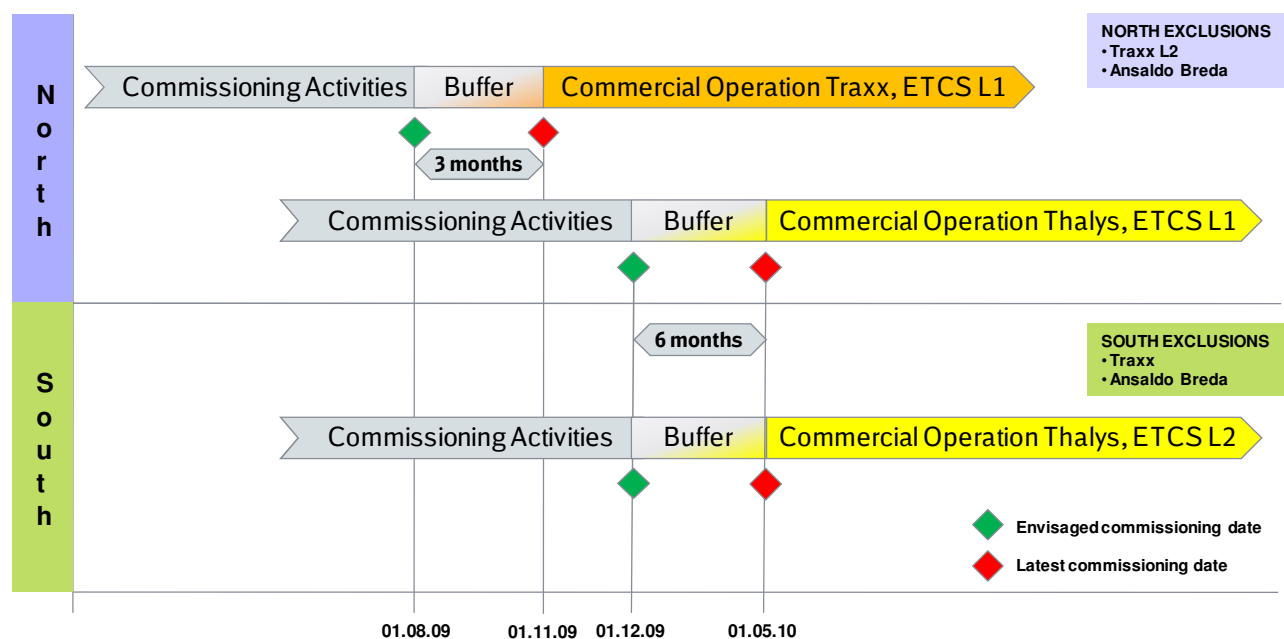

Image 1 - Commissioning Concept HSL Zuid

1.1.2 Status CCS Track Side Assembly

The track side assembly is certified for ETCS version 2.3.0 corridor. The respective certificates have been provided to DBI for review.

Regarding the RBC handover at the Belgian border the certification (including safety testing) is in place

1.1.3 Status Rolling Stock

Currently there are 4 trains foreseen for commercial operation:

- Traxx locomotive, BR 186 with Prio coaches
- Thalys
- BR 189
- Albatros, Ansaldo Breda

The Rolling Stock of Ansaldo Breda is not subject of this study.

1.2 Conditions

Specific restrictions and conditions have been considered for the study:

- 5 hours maintenance window each night is reserved for the whole line
- The “Tunnel Groene Hart” (TGH) on section North has a speed limit for the Thalys of 250 km/h
- Speed limit of 250 km/h due to pressure waves on the Prio coaches
- Temporary Speed restrictions are phased in
 - L1: 80 / 120
 - L2: 80 / 160 / 220
- The message to lower the pantograph at voltage change overs comes from ETCS Balises - to be taken into account for alternatives PZB, ATB-NG, CCS
- Ansaldo Breda trains are not subject of any investigation in this report
- The junctions to Breda and Zevenbergschen Hoek have not been considered in the investigation.

2 ETCS

The objective of this chapter is to assess the given concepts and alternatives, to identify potential risks and to make recommendations for their mitigation:

- Chapter 2.1 analyses the certification and homologation concept for the planned solution: ETCS L1 160 / L2 300 based on SRS 2.3.0 as currently installed on HSL Zuid. Based on international experience in ERTMS projects, recommendations for risk reduction for the planned solution will be made there.
- In chapter 2.2 the alternative solution of extending ETCS Level 1 operation to 300 km/h has been analysed on the basis of the proposal from Infrasppeed.
- Specific questions related to the commissioning strategy are reflected in chapter 2.2
- In chapter 2.3 deals with the recommendations study Phase I which have been substantiated here on basis of the current situation.
- The situation of Rolling Stock related to ERTMS are described in chapter 2.4

2.1 Level 1 / Level 2 as currently installed on HSL Zuid

ETCS Level 2 is the main operating system for HSL Zuid whereas Level 1 is only a fall back system in case Level 2 is not in operation. The relevant certificates are provided and proof that the system is fit for purpose. However, not only the certificates are required as precondition for a successful operation. DBI has analysed the provided documents and reflects upon potential commissioning risks in this chapter.

2.1.1 General analysis of homologation concept for the trackside CC assembly

For the following trackside constituents safety assessments, conformity certificates and declarations are available:

- Eurobalise S21,
- LEU/MSTT,
- LEU S21M,

→ No specific risk is expected from these components.

For the RBC (Radio Block Centre), the central component of the trackside equipment for radio-based ETCS, no conformity certificate was issued. Instead, for the RBC, including GSM-R interface, excluding axle counting system, GSM-R and on-board assembly, an interim statement of conformity is available. The report of the RBC concludes with limiting conditions and non-conformities that will have to be obeyed to grant coherence of the RBC in the systems configuration of HSL Zuid. The final conclusion of the report states that technical interoperability cannot be certified to the full extent as required by the TSI CCS. As no certificate of conformity is available, the supplier did not issue the declaration of conformity.

The non-conformities (Multiple non-revocable temporary speed restrictions within the same message, missing Balise Group at level transition STM-L1) reported and confirmed by ERA (European Railway Agency) lead to a restricted certification by the Notified Body (Interim Certificate of Conformity). However the non-conformities have been evaluated by HSL Zuid and ProRail with the conclusion that these do not constitute a safety risk or operational hindrance.

→ No specific risk is expected from these non-conformities.

Because the scope of Infrasppeed (including Siemens / Thales as suppliers) deliverables does not expand to cover the applicable full set of functional and system requirements as specified by the TSI-CCS-HS for the trackside CC assembly, it is not legitimated to issue a „Certificate of EC Verification” with regard to the legal framework of that assignment. Therefore the results of the NoBo’s verification activities have been documented by means of an EC Verification Report whereby all limitations and shortcomings with regard to the overall verification scope have been made explicit. These points were summarised in three groups of pending issues:

- [PE1] GSM-R; (“not within the scope of Siemens/Thales”; “for EC Verification within the overall scope compliance will have to be evaluated on system level”)
- [PE2] Key Management;
- [PE3] Testing under full operational conditions as requested in the TSI CCS.

In particular, in the reports several indications have been made on issues that have to be tested and verified at system level [PE3].

Therefore on that stage, certification for commercial operation of HSL-Zuid was not possible. To cover the pending issues, in mid 2008 the NoBo has created the *Conformity Assessment Report*, taking into consideration additional documentation to close the pending issues [PE1-3]. The context of the documentation is reproduced here:

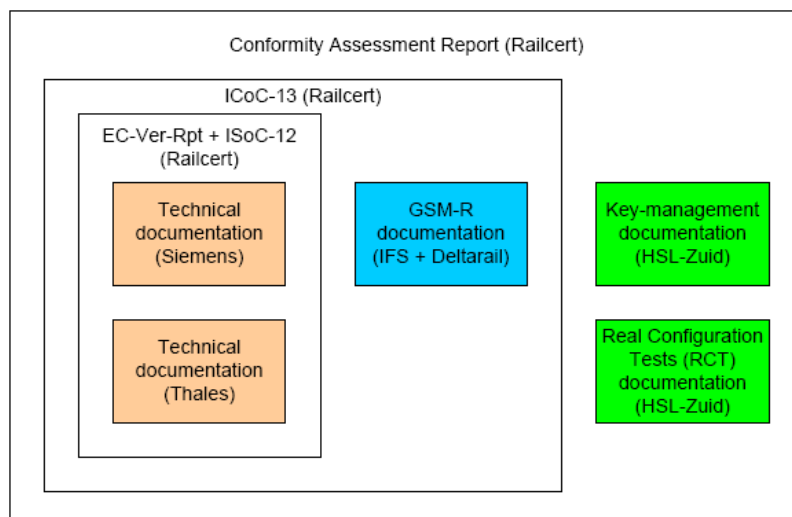

Image 2 - CCS Certification HSL Zuid

With this document, an integrated view on the trackside CC assembly was reached. This integrated approach should be kept.

The successful demonstration that Real Configuration Tests (RCT) has covered all open issues of the preceding reports is the key for final acceptance of the trackside assembly for operation. Issues could pop up from ISA / NoBo statements: e.g. testing under operational conditions, testing under consideration of human behaviour, shortcomings of rules, fall back scenarios, operation with multiple trains, etc.

Because of the key role of the test program, the following recommendation is made:

→ **Recommendation #01**

Due to limited information about the exact test- and validation methods, DBI gives a general recommendation for the border crossing.

Check the Validation Plan (describing the method of making, executing and reporting on the test cases) and the Test Plan for full coverage of the items indicated in the relevant ISA and NoBo reports. Special attention should be drawn to test related fallback scenarios and degraded situations, to the RBC-NRBC handover and tests with more than one train.

If this has been done by HSL Zuid and/or ProRail, as stated by HSL-Zuid and ProRail, and the respective certificates of the NoBo and the ISA are in place, then no specific risk is expected from the border crossing.

2.1.2 Track-Train integration process

The final goal of the HSL Zuid project is to perform safe High Speed operation at high performance level. This means that train operators must be supported to fulfil the necessary conditions.

The track-train integration for a certain train type includes the following aspects:

- Have all exported constraints sufficiently been considered?
- Is the documentation presented by the Infra Provider complete and valid?
- Are the specific solutions of infrastructure (RBC) and Rolling Stock (OBU) interoperable?
- Have all relevant operational test scenarios been demonstrated on system level?

Deficiencies in the co-ordination of the track-train integration would be a major risk for the project timetable.

→ **Recommendation #02**

To reduce the project risk, the track-train-integration process should be co-ordinated and supervised by a *System Integrator* (see also the report phase I). The operational way of organizing the activities of a System Integrator may depend of the level of maturity already reached on the HSL-Zuid. DBI recommends that the parties involved, under supervision of the actual System Integrator (the Steering Committee HSL-Zuid) establish an analysis based on the examples SBB and/or ADIF, on which they also have to take into account the already achieved maturity, to establish the best way to proceed the integration activities.

Best practice examples:

In international projects, the System Integrator role was implemented in different ways, for example:

- In Switzerland by the Infra Manager SBB, also managing the IOP project establishing a rail interoperability laboratory
- In Spain by the Ministry (MFOM), with an independent laboratory at CEDEX (see image 3)

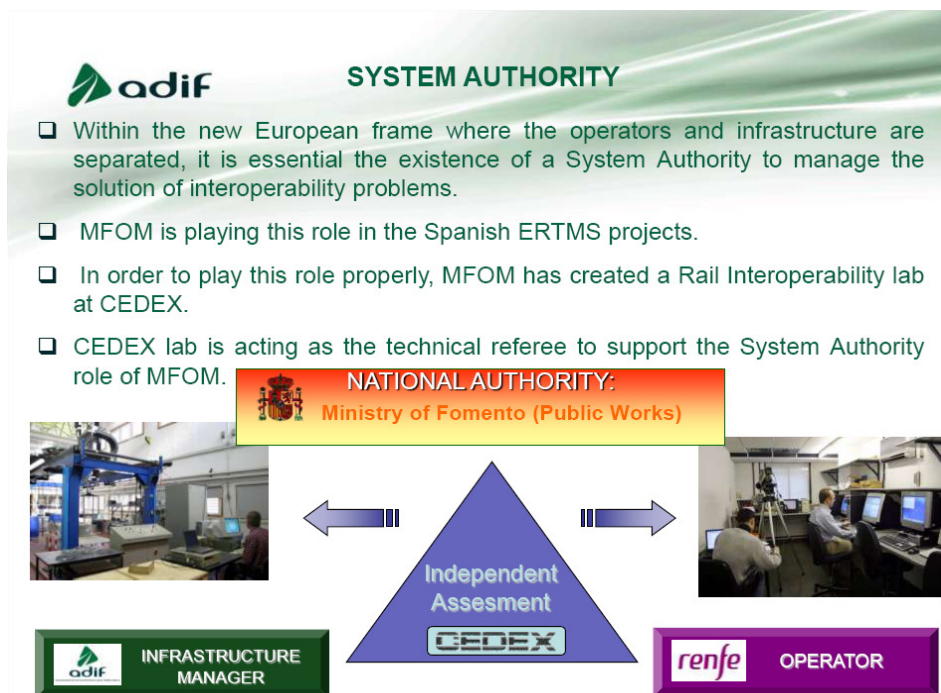

Image 3 – System Authority - ADIF

Remark: A system integrator is particularly needed when the system is immature. A system, in this case ERTMS, is considered immature when much of the problems encountered are caused by multi-interpretable specs (suppliers each develop their own solutions) in a specific sub-system and/or are cross-problems. The latter: both sub-system specs are correct and correctly implemented, but the combination does not work.

Whenever the system gets more mature all these kind of problems are solved. DBI was not able (within the timeframe for elaboration of this study) to determine the level of maturity already reached on the HSL-South. **Therefore DBI is stating the best-practices from abroad as an example, rather than evaluating the actual situation on the HSL Zuid.** If the maturity of ERTMS-systems on HSL Zuid is higher, the role of the system integrator will become less extensive.

A supporting tool is provided in **appendix 7.2**: A risk checklist that could be followed up by the System Integrator. It contains some general project risks, reflecting issues that have been observed in other ERTMS projects (best practice).

2.1.3 Testing on HSL Zuid

EVC's (European Vital Computer) of several onboard units were used to perform the so called RCT tests (Real Configuration Test). Following configurations were available:

Loco	OBU	ETCS Level
BR203/G1206 (Diesel locomotives)	Alstom OBU in combination with an Alstom STM-ATB	Level 1, Level 2, transitions conventional network and Belgium
HLS6264 (Diesel locomotive)	Alstom OBU	Level 1, Level 2, transitions Belgium
Thalys/PBA	Ansaldo/F OBU in combination with an Alstom STM-ATB	Level 1, Level 2, transitions conventional network and Belgium
Thalys/PBKA	Ansaldo/F OBU in combination with an Alstom STM-ATB	Level 1, Level 2, transitions conventional network and Belgium
BR186, TRAXX	Bombardier OBU in combination with an Bombardier STM-ATB	Level 1
Taurus	Siemens Onboard unit	Level 1/2 and transition Belgium
BR189	Alstom OBU with an Alstom STM-ATB	Level 1, Level 2, transitions conventional network and Belgium

Table 1 - ETCS Locos for RCT Testing

The variety of OBU used is a positive indication for the stability of the trackside solution.

Test Duration

From starting testing in 2005, lots of test activities have taken place in the last years on HSL Zuid, including border crossing with different trains. This has resulted in several SW corrections and adaptations. On the other hand, the analyses of the integrated transport-need and/or trains also in other projects have resulted in stepwise adaptations of the implemented version of the ERTMS specifications (2.2.0 - 2.2.2 - 2.3.0).

However, detailed assessment of the test results is unavoidable for a conclusion on the maturity of the process. In the scope and information available for this report, the extent and validity of the test runs already accomplished by trains on HSL Zuid cannot be fully evaluated. Therefore no sound forecast is possible for the remaining duration of tests to reach full operational speed and train frequency.

Some examples from test duration in real projects and factors influencing the test duration are given in the next chapter.

Test Specification

It is supposed that the test specification “*Track to Train Integration Default test set for ETCS L1 and L2 (Version 2.1 Final)*” was used for these tests. Some issues regarding the test specification should be checked by the System Integrator:

- Has the validity of the following statement been checked: “Malfunctioning and defects in trackside equipment is out of the scope for degraded functions, because *it is the opinion* that such malfunctioning shall be part of the respective safety case for Rolling Stock and track.”?
- Does TSI certification allow the use of MIL standard in place of CENELEC?
- Have all exported constraints been checked in their context, impact etc. and tested if applicable?
- Can testing “once” cover the relevant range of parameters? → lab testing requirements

2.1.4 Best practice for Interoperability Tests (IOP)

Remark: *The abbreviation IOP in this chapter is used for Interoperability, especially in the context of exhaustive testing of the compatibility of an RBC with EVC products of different suppliers.*

The approach selected for HSL Zuid for the Trackside CC Assembly is based on the following assumption:

*“According to the TSI CCS, chapter 6.2 the declaration of verification of on-board and trackside assemblies, together with the certificates of conformity, it is sufficient to ensure that an on-board assembly will operate with a trackside assembly equipped with corresponding functions as defined in the register of Rolling Stock and in the register of infrastructure without an additional subsystem declaration of verification.”
(EC Verification Report / Interim Statement of Conformity)*

However, the above assumption must be seen as a mid-term target. *The consolidation of the European specifications has not been finished.* The realisation of the ERTMS projects around Europe has revealed many gaps and uncertainties in the TSI, resulting in an incremental improvement of the specification by introduction of CR (Change Request) and iterating publication of updated technical specifications (e.g. SRS 2.0.0, 2.2.2, 2.3.0d). Many problems were pragmatically solved on product level. The formal verification of conformity with the technical specifications is a necessary condition. Despite of the high *symbolic value of an EC Declaration of Verification* for the assembly, it does not guarantee full interoperability and safe co-operation of specific on-board and trackside assemblies under specific operational conditions.

To mitigate the risk of stepwise discovery of problems during commercial operation, extensive testing of the full system range is required.

Best practice example (RFI, Roma-Napoli Level 2 High Speed Line)

In April 2004, first trains were running at 300 km/h under ERTMS full supervision.

The line has opened 21 months later for passenger operation after extensive and exhaustive testing. Testing on site was systematically supported by laboratory testing in the RFI test laboratory, using the original HW, SW and engineering data of the line and train.

It took another year to go from 2 connections per day to nominal situation (12 per day). (A similar observation was made in the commissioning process of the Betuwe Line.)

Best practice view of an UNISIG supplier:

“Site tests without prior intensive lab tests require a lot of efforts, for a low coverage of ETCS functions. Interoperability cross-tests cannot substitute comprehensive testing.”

To avoid a scenario of “endless on site testing”, especially for ETCS Level 2, systematic interoperability testing, including laboratory testing, is recommended. See also the considerations in the best practice example from Adif:

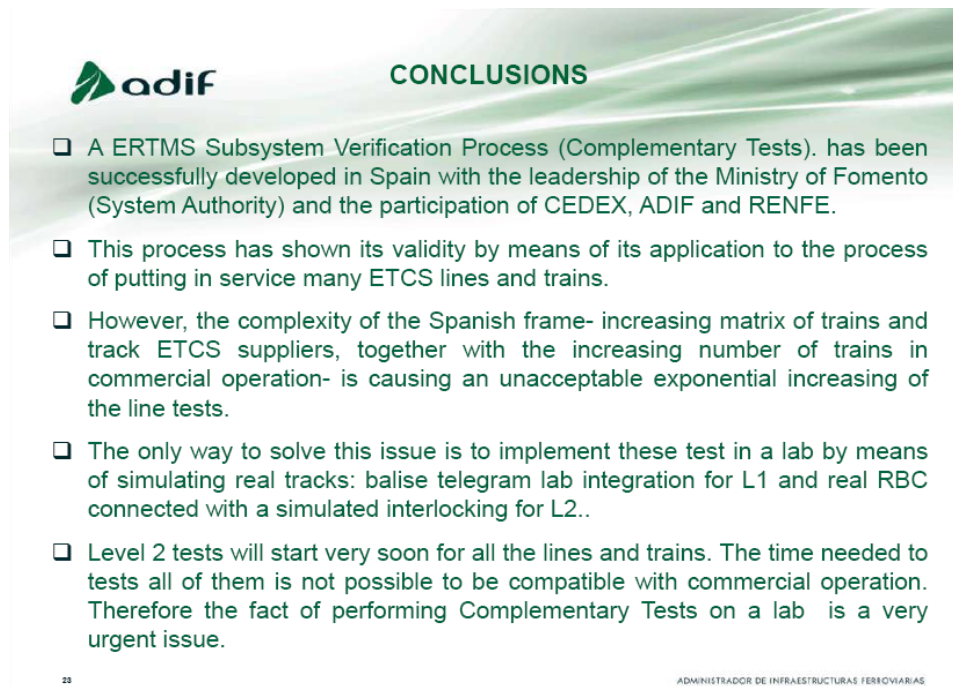

Image 4 – Conclusions ADIF

Best practice example (Deutsche Bahn, Level 2 pilot line Berlin-Leipzig)

The coverage of testing functionality and safety related issues by supplier’s lab tests did not fully convince the NSA and Infrastructure Manager. As a result, the system (track + train) had to be tested extensively after delivery on site. Several software adaptations were necessary due to detected findings during testing. As a consequence the commissioning for passenger transport has been delayed by almost 2 years. The findings confirmed that the exhaustive tests were necessary.

Best practice example (SBB, concept for safety approval for trackside X with train type M/L/N)

An overview of the SBB Process for safety approval is attached in **appendix 7.3**. The overall safety case (I) takes into account the safety cases of the assemblies (II-for each train type M/L/N, IV-for trackside X) as well as an integrated safety case for the specific combination train type M/L/N with the trackside X (V).

Because of the immaturity of the European specifications, and forced by major interoperability problems and project delays, during the SBB projects a supporting process of IOP testing (III) was set up in a specific test laboratory environment, bringing together the RBCs and EVCs of different suppliers for IOP testing. The results of IOP testing of the RBC used in track X with the EVC used in train M/L/N (III) are taken into account in the overall safety case.

IOP testing covers a broad set of test cases specified according to the specific track implementation & operational principles. It consists of a laboratory test session (using the real RBC and EVC equipment) and complementing site tests for test cases that cannot be featured in laboratory. IOP testing is effected by the respective suppliers and should be spot witnessed by the System Integrator and certification bodies.

Although this kind of test is not requested (and not intended) by TSI, it enhances confidence in the product compatibility and significantly reduces project risks. Findings are mainly product related, in some cases also related to different interpretation of the TSI specifications.

In particular for the RBC, the European Specifications are still leaving too much freedom for implementation for the suppliers. As a consequence, EVCs that have been successfully tested within a specific RBC environment, frequently failed in a different RBC environment because the engineering choices taken for the second RBC (e.g. frequency, sequence or composition of data transmitted) were different.

The following “IOP-status” has been reached for the Thales RBC:

EVC supplier	IOP (lab + site) test campaign	reference project *)	Real Configuration Tests (by HSL Zuid Project organisation) with target train and target HW/SW version
EVC Alstom	YES (Lötschberg version)	Lötschberg	BR189: tests planned for HSLZ
EVC Ansaldo/F	not known	none	Thalys: some tests done on HSLZ, still problems (as of march 2009)
EVC Bombardier	in preparation (Lötschberg version)	none	TRAXX: tests on going on HSLZ
EVC Siemens	YES (Lötschberg version, HSL Zuid version)	Lötschberg, Berlin- Leipzig	not planned

Table 2 - Interoperability status Thales RBC

*) To decrease the risk for HSL Zuid, a full-range test campaign of the relevant supplier combination in the frame of another project could be referenced. In this case the supplier compatibility is proven at least for the specific RBC solution and SRS version (222+X, with “X” project specific). However, the specific operational requirements and technical solutions for the HSL Zuid would not be fully covered.

The duration of one IOP test campaign for Level 2 can be assumed 3 weeks laboratory plus 2 weeks site tests per session (one EVC). In case that IOP problems will be found that require an upgrade of the on-board software, this upgrade would take further 4-6 months, including repetition of the relevant part of the test session.

For HSL Zuid RBC/engineering IOP laboratory and site tests have already taken place with Siemens EVC. Thus, it can be assumed that all technical conditions (IOP test scenarios, etc.) for testing with other EVCs are available.

→ Recommendation #03

To decrease the project risk, for each planned train it should be verified if the extensive HSL Zuid test activities of the past years are already equivalent with a laboratory supported exhaustive IOP test campaign as described above, i.e. if they have appropriate coverage of functions and parameters and were based on the target HW/SW/engineering versions of EVC/RBC.

If not, it should be stipulated for each combination RBC (Thales) - EVC (Alstom, Ansaldo, Bombardier) that IOP testing will be completed, using the project specific RBC hardware/software/trackside engineering version and based on the project specific operational scenarios. This could become a condition of ProRail to the supplier/TOC for access of the respective train for final system validation tests (Real Configuration Tests)

For the HSL Zuid project a supplier independent laboratory environment does not exist. The use of the supplier's laboratories seems the only realistic way to complement site tests by lab testing.

As a measure to reduce the duration of the testing period, ProRail could attend the IOP site tests and on that basis decide which of the system validation tests are already covered by the IOP test campaign.

Remark: In the meantime, UNISIG has developed the IOP test approach into a universal concept of interfacing supplier's laboratories (see UNISIG subset-110/111/112). This is supporting the implementation of projects and product debugging in a pragmatic way. However, the railways' interest is to improve the TSI standards in such a way that in the future (ERTMS Baseline 3) the EC Verification process will be sufficient to ensure interoperability.

2.1.5 Best practice for Integrated Safety Case

A second conclusion can be drawn from the SBB concept for safety approval (see appendix 7.3). The project documentation includes an individual safety case for the specific combination train type M/L/N with the trackside X (V) as well as an overall safety case (roof document) for this combination (I). This document should be part of the technical file for TSI- and ISA assessment RS. A similar document or a concept describing it, was not included in the documents available for this study. *(I) Overall safety case for track X and train type M/L/N: Roof safety case document which is certifying that any train of type M/L/N can safely operate on track X (engineering, operation) and all necessary documents (safety case, expert's report, validation reports, etc.) of the previous process steps for train type, track and their interaction are complete, in form and content correct and available.*

(V) The Safety Case for the safety relevant application conditions from track to train and vice versa. Evaluation and verification of the implementation of the resulting measures. Includes a test report for the verification of the tests prescribed by the IM (Infrastructure Manager).

In the SBB process, the infrastructure manager is responsible for these documents. This process was successfully applied for the commissioning of hundreds of ERTMS Level 2 trains from different suppliers, including the ICE 1 trainset from Deutsche Bahn.

As we understand an Integrated Safety Case, including the effects of extensive IOP-testing, including lab and on-site RBC-testing, including cross-border RCT, for the HSL-Zuid has been already established. This suggests a higher level of maturity, and therefore an adapted approach towards integration can be considered.

→ Recommendation #04

The current commissioning concept of HSL Zuid is based on a dedicated train-track configuration that has been tested and validated. Any crucial change of configuration (e.g. Rolling Stock / OUB - Infrastructure / RBC) requires further tests and train-track-integration processes.

The integrated safety case (V) is the central document for the Homologation of the signaling system in the train in its specific national operating and technical environment. The overall safety case (I) is the basis for the authorization (NSA) to start operation.

2.1.6 Summary

- The certification and homologation concept is in general applicable, enhancements to gain integrated view are recommended.
- The documentation assessed for this study do not allow a sound forecast of the maturity of the transport-system and therefore on the remaining duration of tests to reach full operational speed and train frequency.
- The train-track-integration, including an integration safety case should be co-ordinated and supervised by a System Integrator. The actual way of organizing the activities of the System Integrator may depend of the level of maturity reached on the HSL-Zuid. The checklist (7.2) can be used to determine this level of maturity.

2.2 Level 1 with 300 km/h

Even though ETCS Level 1 is a fall back system on HSL Zuid, it could be also used for commercial operation. Considering the commissioning concept of HSL Zuid the benefit would be to operate the Thalys on North with High Speed. The current commissioning concept does not envisage the operation of ETCS L2 on North.

The current system design of ETCS Level 1 has been established on basis of maximum speed 160 km/h. It is possible to operate L1 also with higher speeds. This depends on the technique, operational rules and safety rules and varies from country to country.

Infraspeed established a concept how the current L1-system on HSL Zuid could be modified in order to enable the operation with maximum speed up to 300 km/h.

DBI performed a brief assessment of the concept. The conclusions are comprised in this chapter.

2.2.1 Description of Status Quo

For the HSL Zuid line ETCS Level 1 with 160 km/h is installed as a fallback system. The interlocking and the position of the balises as well as the block sections are designed for maximum speed of 160 km/h.

The block sections are identified by markerboard on the track. The markerboards are equipped with overrun lights. The overrun lights show the “drive”-aspect of the virtual signal. The line has no infill information by infill balises or infill loops.

The existing balises are built in the gap of the derailment plinth. For this reason it is difficult to adjust the existing balises or mount additional balises.

The signal aspect is shown to the driver by the ETCS onboard unit. Because there are no infill balises and no infill loops, a changed signal aspect won't be transmitted to the onboard unit in front of the signal. The signal aspects are only transmitted to the onboard unit when the train passes the balises at the location of the markerboards.

2.2.2 Balises

The North and the South section of HSL Zuid has in total about 400 Balise groups with approximately 650 balises. About 400 of these balises are fixed balises with static telegram. An update of the balise telegrams is not required according to the current planning but has to be investigated within an explicit system design.

2.2.3 MSTT

The switchable balises (transparent balises) are controlled by MSTT (modular locally controller). The MSTT receives the Movement Authority by ISDN-bus from the interlocking. All this information must be changed for an upgrade of the speed to 300km/h. To realize this change, a project data modification at MSTT is required.

It is possible to change these data during the weekend but it is scarce due to required tests and time to adapt the data of approximately 250 MSTT.

2.2.4 Interlocking

Minor modifications of project data in interlocking are required to extend particular blocksections (in front of tunnels).

Infraspeed distinguishes between interlocking system software and engineering data. The engineering data depends on the topographic and operating parameters, not the system software. According to Infraspeed this modification is not a crucial system change and can be applied without major approval and safety processes.

Based on past experience, DBI recommends to assume that the combination of system software and engineering data will have to be tested together. In Germany a change of project data is a crucial system change and requires comprehensive validation, testing and safety analysis.

2.2.5 Additional Balises

Infraspeed determined a minimum of 4 additional balises to enable the upgrade to 300 km/h with the ETCS Level 1 system. These 4 balises should replace the existing ones. Nevertheless, an explicit design could result in additional balises. Furthermore the adjustment of the position of existing balises could be required. This is associated with high costs and time because of necessary construction works at the derailment plinth.

2.2.6 Certification and approval

The redesign details for the upgrade of ETCS Level 1 – 300 km/h have to be designed, approved, tested and verified. ETCS Level 1 with 160 km/h is designed as a fall back system to increase the availability of the track. For this purpose it was installed, tested and certified. The NoBo's *Interim Certificate of Conformity* is defining the range of the certification as follows:

“HSL-Zuid CCS trackside assembly is designed to operate in ETCS Level 2 as the regular mode of operation. Degraded or fallback operation is supported by means of ETCS Level 1.”

The frequency of the usage of a technical and operational solution (regular or fallback) and the speed at which the system will be used (160 or 300 km/h) has an implication on the quantitative safety target of the overall system. In the documents available for this study, no reference was made to such analysis. The concept of Infraspeed did not reflect upon this scope.

2.2.7 Conclusions

In order to use ETCS Level 1 as the regular mode of operation at 300 km/h, it is necessary to adapt the safety case as well the certification and approval by the Notified Body and the NSA (National Safety Authority). This is a **major project risk**.

Infraspeed intends to test the components and the software with known scenarios in a laboratory. This does not replace track side tests with the original hardware, trains and the original operational conditions. The trackside upgrade to ETCS Level 1 with 300km/h must be tested before start of commercial operation.

A trackside redesign from 160km/h to 300km/h (e.g. on a weekend) is accompanied with risks for the line in operation. More time might be necessary to transfer the system from L1 160 km/ to 300 km/h. This depends on the test program on-site, the scenarios to be tested and the requests of the NSA, ISA and responsible operators.

Summary:

Even though that the concept of Infraspeed is a considerable solution to upgrade the system from ETCS L1 160 km/h to 300 km/h, it has to be thoroughly prepared, especially by involvement of NSA, ISA and the operators. The current concept does not yet contain details about an on-site test program, scenarios to be tested and the required efforts for safety approval.

Risks remain for the project, if this solution would be implemented during HSL Zuid is in operation (e.g. during weekend). The time to execute all required activities for re-programming, testing and approval is scarce.

To allow a comprehensive analysis of the impact and risks, the concept should at least contain:

- Detailed system design
- Program of lab testing
- Operational Impact Analysis and concept of scenario testing
- Train-Track integration analysis
- Safety Case / Certification analysis - NSA, ISA
- NoBo process and contractual consequences
- Commissioning & testing strategy

2.2.8 Stepwise commissioning

The commissioning concept as presented for this study includes two major steps:

- Step 1: Level 1 operation with TRAXX on the North section
- Step 2: In addition level 2 operation with Thalys at the South section and level 1 operation with Thalys on the North section

International experience is showing that in the most cases a stepwise approach was implemented instead of a sudden start of full commercial operation under ERTMS responsibility. Typical steps in this process are:

1. Site tests without safety responsibility of ERTMS (SeoSV)

They are used to check technical functions as part of IOP and system validation. These tests require train protection by other measures and have strong impact on lines that are already in operation. An option is that a conventional fallback system is used and ETCS is running in parallel. Such fallback system is not available for HSL Zuid.

At HSL Zuid, the Thalys and BR 189 trains are still at this stage.

2. Site tests with safety responsibility of ERTMS (SEmSV)

These tests take place in the real operational environment. These tests normally start under specific observation (e.g. second driver) and without passengers, in High Speed projects sometimes at reduced speed. They are used to collect performance and reliability data to supplement the safety case and to gain confidence for revenue service. The impact on lines already in service is limited.

At HSL Zuid, the TRAXX train is at this stage for level 1 at the north section (Inzetcertificaat).

3. Revenue service with restrictions (reliability test)

These tests allow commercial use of the system, but still with restrictions on the operations like reduced train frequency and specific observation. After a period of successful operation without incidents the restrictions will be released.

The overall duration (from 1 to 3) can take up to two years (see best practice examples). Period 3 takes the main part – the restrictions in train frequency have to be accepted for about 12 months. The duration of period 1 and 2 is mainly depending on the number of iterations, i.e. software changes and subsequent repetition of tests; each iteration extends the period by about 4-6 months. Therefore, on the basis of the documents and timeframe available for this study, a sound estimation of the remaining test duration for the trains on HSL Zuid (to reach full operational speed and train frequency) cannot be made.

→ Recommendation #05

- A stepwise commissioning process should be envisaged, including a long period (<>12 months) of commercial operation with limited train frequency.
- Efforts for reduction of the testing period should focus on the first step, because these tests are very difficult to organise when a line has been already started revenue service. Reduction can be reached by the use of extensive IOP testing in laboratory (see recommendation #03).
- Due to additional risk, cost and time it is not recommended to install a national fallback system only for the testing period.

The envisaged frequency of trains for the first 2 years of operation on HSL Zuid (see also report Phase I), would enable the execution of the third (reliability) test phase.

2.2.9 Regression Testing

Site tests without safety responsibility are necessary for each new train on the line. But also in case of software changes at a (homologated) train for this line (bug fixing, functional enhancements, upgrade to SRS 2.3.0d or SRS 3.0, etc.), some tests without safety responsibility could become necessary.

After start of operation, these tests must be normally done in periods without regular train operation. HSL Zuid is a pure passenger line. Free periods (at least 2-4 hours) probably will be available during the nights. Nevertheless, these tests remain expensive and difficult to organise and a reduction of site tests on the operational line by enhancement of the laboratory tests is recommended (see recommendation #03).

2.2.10 Applicability of level 1 as regular mode of operation

The *Interim Certificate of Conformity* is defining the range of the certification as follows:

“HSL-Zuid CCS trackside assembly is designed to operate in ETCS Level 2 as the regular mode of operation. Degraded or fallback operation is supported by means of ETCS Level 1.”

The frequency of the use of a technical and operational solution has implications on the quantitative safety target of the overall system. In the documents available for this study, no reference was made to such analysis.

→ Recommendation #06

Although the preparation of the commercial use of the HSL-Zuid with TRAXX (Prio) under L1 is at an advanced stage, including the involvement of the NSA, it should be checked with the NSA if the use of ETCS Level 1 as a safe regular mode of operation is acceptable. The *Certificate of Conformity* might have to be extended.

2.3 Substantiation of recommendations report Phase I

2.3.1 System Integrator

Study, Phase I recommendation:

It is recommended to bundle all responsibilities for the overall system (ETCS trackside and onboard equipment, GSM-R, test equipment) in one hand, e.g. ProRail, and to privilege this System Integrator with the necessary decision competence for system integration issues. This should be required in particular with regard to definition, execution and evaluation of tests.

→ This recommendation has been substantiated in this report, see recommendation #02.

2.3.2 Test Train and High Speed Serial Trainset

Study, Phase I recommendation:

*For the preparation of commercial operation with High Speed trainsets, the early acquisition of a **Test Train** with ETCS equipment of the planned serial High Speed trainset's ETCS supplier is highly recommended. Ideally, this Test Train should be owned by the System Integrator. With this train could be done onsite tests yet before delivery of the first serial trainset.*

→ The gist of this recommendation was in fact fulfilled by the RCT program, using OBUs of different suppliers. Related to the Ansaldo Breda HS trainset the recommendation remains in force.

2.3.3 Test Laboratory for ETCS Level 2

Study, Phase I recommendation:

*For the system integration of ETCS Level 2 is further recommended that at an early stage the supplier should provide the original HW/SW configuration including trackside engineering in a **Test Laboratory**.*

On-site tests are more expensive and time consuming than laboratory tests. Extent and quality of laboratory tests have substantial impact on the extent and success of on-site tests! Laboratory tests can start early before delivery of a train and will reduce the time between train delivery and putting into operation.

→ This recommendation has been substantiated with a concrete proposal to stipulate IOP testing by the suppliers, see recommendation #03.

2.3.4 Homologation Process

Study, Phase I recommendation:

It cannot be assumed that the declaration of conformity with the TSI will be sufficient to reach the safety targets. ... To minimise this risk, it is recommended that the System Integrator, yet before the Serial Train will be available, agrees a project specific approach with all involved parties (both suppliers, NoBos, NSAs, train operator, track operator).

→ Based on the best practice example of the SBB process for safety approval, this recommendation has been substantiated with the proposal to create an integrated safety concept.

2.3.5 Specific Analysis on NRBC handover

Study, Phase I recommendation:

To minimize the risk for putting into operation ETCS Level 2, an interim solution with border crossing via ETCS Level 1 should be envisaged.

→ This recommendation has been overruled by the actual HSL Zuid Commissioning Plan. However, in the documents available for this report, no explicit evidence was found that the RBC-NRBC handover has been sufficiently tested, taking into account the remarks from the underlying reports. E.g. the ISA report of 15.05.2008 states: “*The crossing of the border in ETCS level 2 is only allowed for test purposes, without any safety responsibility of the RBC.*” This was reflected in recommendation #01.

Remark: *DBI has been informed that the actual state of the border-crossing (RBC-handover) might be more advanced than the quoted ISA-report suggests. The status of the quoted report is May 2008. DBI has not been able to check this statement in the limited time available.*

2.4 Rolling Stock ETCS

Test runs with the train sets Thalys and the loco class 186 have been executed on HSL Zuid. DBII assumes that these test runs with the locos were successful. The loco class 186 holds an “inzetcertificaat for proefbedrijf”, which means that all types of transport apart from driving with actual passengers is allowed. There is no technical hindrance to upgrade to commercial operation.

The loco class 189 also has made some test runs on the HSL Zuid. The final results are not known to DBI and apparently also the VGB for commercial use is not yet in place. To get this VGB the homologation could be made on the basis of the test results and the reports of the NoBo. Currently there are test runs on the HSL Zuid with loco 189 065 including the newest software from Alstom for Level 2 SRS 2.3.0.d (called 5.2.0.+).

The Thalys train sets have some problems in the test runs and must be optimized. The Thalys is currently only released for testing. It is currently planned to return to the track with software version 7.2.3.1 RC2 in the middle of the year 2009 for final testing. The Thalys train sets could be ready for public traffic in minimum 9 months (6 months for testing, 3 months for homologation). The PBKA Thalys are currently in alteration and will be ready until February next year, the alteration of the PBA Thalys are nearly ready.

2.4.1 Homologation

2.4.1.1 Homologation (Evaluation of certificate Traxx BR 186)

The result of the researches by the manufacturer of the loco class 186 is the statement that the VGB for ETCS Level 1 at the HSL Zuid is still applicable. There is no restriction in the homologation. This is also verified by ProRail. There is no further homologation necessary.

2.4.1.2 Homologation (Evaluation of certificate Thalys train set)

After the new test runs beginning in May 2009- over at least 6 months there is in addition a homologation time of approximately 3 months (to proof the safety cases, data preparation, exported constraints, etc.).

2.4.2 Potential risks

Therefore there will be no risk coming from the loco class 186. To use the loco class 189 for public operation a VGB is required. A risk is coming from the Thalys and its modifications. Test runs are required to validate the modifications before commercial operation.

2.4.3 Recommendations

The decision to use the loco class 186 for the commercial traffic under ETCS L1 on the HSL Zuid is connected with the lowest costs and risks and the commercial traffic can be started immediately. The next possibility to start with a commercial traffic is to use the loco class 189. Here it is necessary to obtain a VGB (approximately 3 months).

The Thalys train sets are ready for use in minimum 9 month after beginning the final software test. It is possible that these tests are not successful and more tests are needed for a homologation and the commercial traffic. In this case the time to use the trains set will be extended.

Time and costs:

Time

months	1	2	3	4	5	6	7	8	9	10	11	12
BR 186, L1	◆											
BR 189	Homologation			◆								
Thalys	Final Test						Homologation			◆		

Table 3 - Timeschedule Rolling Stock ETCS

Costs

T Euro	50	100	150	200	250	300	350	400	450	500	550	600	650	700	750
BR 186, L1	---														
BR 189	Homologation														
Thalys	Test Runs										Homologation				

Table 4 - Costs Rolling Stock ETCS

3 Alternative Signaling Solution without CC System

3.1 Introduction

The implementation of new signaling systems requires temporary solutions for the transfer from one stage of implementation to the next. During such work phases, it is common praxis to accept a reduced technical safety level for limited periods and to mitigate the remaining risks to an acceptable safety level by procedures and additional staff resources (e.g. second train driver). Also for HSL Zuid, such solution could be applied. The proposal made hereunder could become operational for a certain period at an acceptable safety level. It forms the basic requirement for the ATB-NG and PZB solution. That means, the so-called “No CC-Solution” constitute the technical basis for the ATB-NG and the PZB solution, e.g.:

- Installation of announcing signals at the entrances of HSL Zuid
- Clamping of switches (emergency cross-overs)
- Prevention trains entering a tunnel in calamity mode
- Prevention collision of train with a water barrier closing or in failure mode

3.2 Brief presentation of functionalities

3.2.1 General

“No-CC system” means that trains are running on the HSL line without train protection system and within the boundaries of conventional signaling with the existing ATB-EG system.

The safety critical issues are

- Respecting the maximum speed on the HSL line
- Protection of the emergency cross-overs and branch lines on the HSL line
- Ensuring safe train spacing by combining the block section on the HSL line to one section between the adjacent conventional sections
- Ensuring safe train speeds by reducing the speed on the approach to the home signal when the home signal shows danger aspect or reduced speed.

The layout of the HSL line from Hoofddorp to the Belgium border is shown on the figure below. The HSL line signaling is made without wayside block signals and without protection signals for crossings, junctions or for tunnel protection. These functions are embedded within the ERTMS system. Without ERTMS system, these protective functions must be substituted by wayside signals or by other measures. The introduction of wayside block and protection signals have been abandoned during the first phase of the study due to the high costs, the resulting fundamental changes of the already installed systems and the considerable time span for implementation. Therefore, in this report only alternative measures will be described, which do not require extensive modifications of already commissioned interlocking.

The basic requirement for the No-CC system is the permanent locking of all elements on the track between adjacent conventional sections and combining the multiple block sections to one block section between two conventional sections. For train operation up to the border to Belgium the line bifurcation to Breda and Zevenbergschen Hoek must be neutralised. The analysis stops at the border to Belgium. It is understood that similar modifications are necessary on the Belgium side when cross border operation should be made in the same manner.

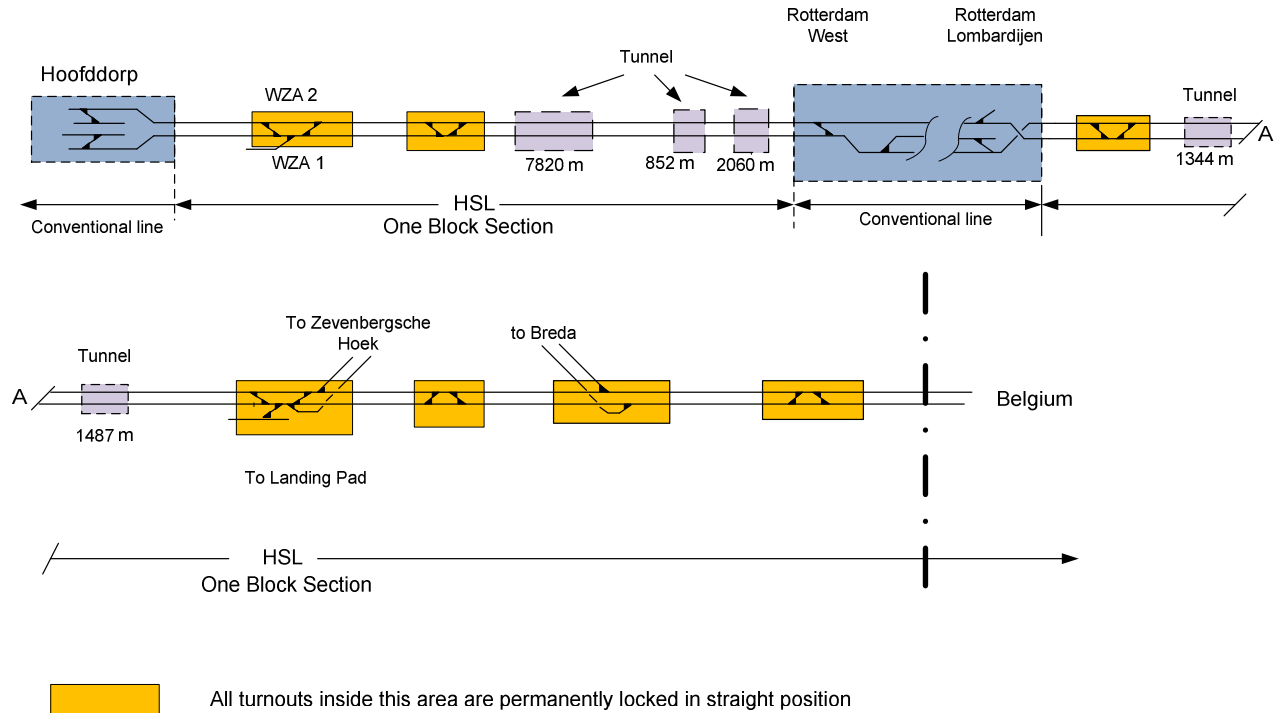

Note: HSL Line to Breda and HSL Line to Zevenbergsche Hoek is closed

Image 5 - Principle line configuration "No-CC system"

3.2.2 Respecting the maximum speed on the line

Without CC system, the train speed is technically limited only by the train propulsion system itself. To limit the train speed by limiting the traction current of the train is technically feasible but not recommendable. In the case of HSL Zuid and considering the locomotives, which are planned to operate, we can see that nearly all train sets are already equipped with the PZB onboard unit, except the Thalys PBA where minor modifications are required. Therefore, it is recommendable to use the PZB on board unit for limiting the line speed independently of the line side PZB application. For safety reasons, the speed might be limited by procedure to 140 km/h whereas the emergency brake will be triggered at 165 km/h by PZB without line side PZB installations.

3.2.3 Protection of turnouts on the HSL section

Protection of the emergency crossovers connection points to the branch lines can be made as follows:

- Protection by wayside signals train routes and integration into the interlocking
- Mechanical locks and key release instruments on site
- Mechanical locks and key release instruments in the adjacent signal operator room
- Mechanical lock and sealing the key in the next signal operator room
- Electrical locks on site

Emergency crossovers are not required for the temporary operation. Therefore, it is proposed to lock the cross-over by mechanical locks. For short period, it would be sufficient to seal the key on a key board inside the adjacent signal operator room. For longer periods, the key should be locked inside an indoor key release instrument. For manual reversing of the cross over e.g. for maintenance work, the key has to be taken and the turnouts unlocked on site. Reversing should be made only by hand operation (cranking).

Emergency crossovers will be set in the straight position and mechanically locked by safe locking devices. The locking mechanism shall clamp the closed blades to the stock rail and shall ensure a sufficient gap for the passing wheel flanks. An example of such point hand locks is shown below.

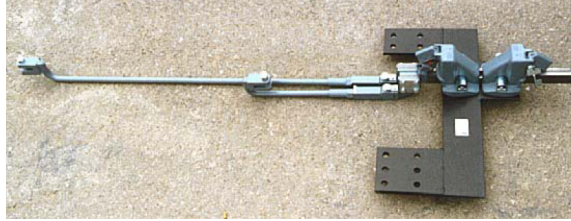

Image 6 - Handlock for switches

Only when the blades are in the correct final position and locked, the key can be withdrawn. Electrical locking devices require modification of the interlocking system and extension of the cable network. An electrical locking system is considered as to excessive for the temporary situation except for the branch lines.

The turnouts leading to the branches to Breda and to Zevenbergschen Hoek should be neutralized and locked in the same manner. Maintaining traffic on these branch lines would require temporary interlocking installation with all necessary modifications, which is considered as to excessive for a relatively short period of operation. The implementation of such interlocking would not be possible within 3 years. The key for the protection of the turnouts leading to the branch lines should be locked in a key release instrument or the turnouts should be locked electrically and supervised by the interlocking and block system.

3.2.4 Combining the block section on the line to one section between two stations

The line section between two adjacent conventional sections is divided into block sections where each block section can berth one train with a safety distance to the next train. Without line side block signals or without ERTMS, only one train is permitted per track between two adjacent conventional sections. Therefore, the block system must be complemented by a station-to-station block system. In order to ease the modification and to avoid heavy retesting at a later phase it is recommended to install a complete new axle counter system for the station-to-station block and keep the already commissioned signaling infrastructure - as far as possible, unchanged. The already placed ERTMS stop markers should be covered. In case of space or cable constraints for additional axle counters, the rewiring of the first and last axle counter point could be considered. To monitor the additional axle counters, the same system has to be applied as for the existing axle counters. The particular connections have to be realized.

3.2.5 Reducing the speed on the approach to the home signal

Train drivers must be informed in advance when approaching a home signal in order to be able to reduce the speed accordingly, either to stop in front of the signal, when showing danger aspect or to pass at a reduced speed. For this purpose, the installation of a distant signal at the braking distance to the home signal is compulsory. For systems with active train protection, the speed and the brake curve is supervised by the CC system. A potential hazard exist for trains without active CC system in the sense that train drivers may not recognize the distant signal aspect or they will not react correctly for whatever reasons. Therefore the speed for railways without CC system is normally limited e.g. in Germany to 100 km/h -120 km/h. The distant signal has to be connected to the home signal of the conventional line.

3.2.6 Train operation in normal direction of traffic

Train operation on HSL lines will be based on the correct driver actions according to the signal aspects. Within the boundaries of conventional signaling, the speeds and correct driver reactions are supervised by the ATB-EG system. The driving of a train with the correct speed profile depends on the performance of the train driver. On the HSL line, a second driver should be employed for safety reasons. As an additional mitigation measure, the line speed should be reduced to 140 km/h by procedure whereas the train borne PZB -if applied - will trigger the e-brake at $V > 165$ km/h

3.2.7 Reverse signaling

For the reverse direction, the distant signal could be replaced by a dummy mechanical signal or a special plate that indicates to the train driver a permanent “Warning” aspect, meaning the home signal shows danger aspect. When approaching the main signal, the driver can recognize the true main signal aspect and react accordingly. From DBI point of view, this solution could be applied for the reverse direction but not for the normal direction of traffic. Otherwise, the signal clearing to the reverse direction should be blocked and trains might operate in reverse direction by running at sight. The signal blocking to the reverse direction can be easily implemented via the new station-to-station block system.

Protection of reverse running is considered as an option and is not included in the cost calculations.

3.2.8 Tunnel Protection / Water Barriers

The tunnel protection is required in order to inhibit train movements into tunnel section when the tunnel supervision system is in alert status. For protection of the tunnel, three solutions seem to be possible:

- Protection by wayside signals, controlled from the CBI (Computer Based Interlocking) with or without train sectioning functions
- Protection by wayside signals controlled from small local control devices, not included in the train sectioning system
- Blocking the departure of the adjacent conventional sections, when one of the tunnels on the line section is in alert status. (This solution is also applicable for water barriers)

The first solution is considered as not feasible due to the involved excessive modifications and exceeding the possible signal control distances. The second and third solutions are technically feasible. However, the acceptance by the safety authorities must be clarified. For the purpose of the cost estimation, the second solution has been considered for the Shield Driven Tunnel on the Northern section due to its length of 7.82 km. For all other tunnels and water barriers, the third solution will be applied. This approach is not acceptable for short headways in the future but should be acceptable for the operational scenario of three trains per 2 hours as specified as operational scenario.

3.2.9 Control and supervision of traction power switching

Traction power switching at VCO's (Voltage Change Over) is out of the “No-CC” solution and must be covered by procedures. The train system itself is protected against erroneous power switching.

3.3 Description of main interfaces

The “No-CC” solution is a standard signaling modification with standard interfaces to interlocking, HMI in the local interlocking and the OCC as well. No particular interfaces to other systems exist.

3.4 Required modifications

3.4.1 Interlocking / HMI (Human Machine Interface)

The following modifications are required

- New hardware such as signal control units for the new distant signals and axle counters
- Modification of the interlocking software and the HMI software. The distant signal status could be indicated outside the track scheme on the HMI in order to minimize the modifications
- Implementation of the station to station block with the new axle counter circuit and neutralizing the existing block sectioning
- Installation of indoor key release instruments for branch lines and a sealing the key at a board within the operator room for emergency cross-overs
- Modification of the Block control and supervision function at interlocking and OCC (Operational Control Centre) level

3.4.2 Signals

One distant signal per home in the normal direction of traffic including the control box must be installed.

3.4.3 Point machines and turnouts (Emergency cross over)

The point machines remain connected to the switchblades for supervision and manual reversing, if required. The point will be blocked against throwing at HMI level and by software change (inhibition of unblocking command). Mechanical point locks shall be installed.

3.4.4 Axle Counter

One axle counter circuit for each intersection has to be installed by keeping the existing axle counter system intact to ease the later transfer to the ERTMS system.

3.4.5 Cable Infrastructure

New cables to the distant signals and axle counters are necessary up to the point where sufficient spare conductors are available. To the distant signals, an eight-core cable is required, to the axle counters one quad or a fiber optical cable is required

3.4.6 Required connections

Distant Signals – Interlocking

Standard solution by copper cable connection

3.4.7 Key-Release instruments – Interlocking

As the key release is related with the block section, the interface could be simplified by linking the key lock/unlock supervision to the new block system. It is proposed to protect the emergency crossover on the line by sealing the key on a particular board inside the operator room, because

these turnout might not be used at all during the temporary situation. The access point to the branch lines to Breda and to Zevenbergschen Hoek should be protected either by key-release instruments or by electrical locks, which are integrated in the interlocking logic because the branch lines might be used for maintenance or later for the preparation of the switch over to the final ERTMS system. A more detailed analysis with respect to acceptability from a safety point of view is required at a later phase.

3.4.8 Power Supply

No modifications are required.

3.4.9 Installation constraints

Spare places for the new hardware must be made available.

3.5 Schematic drawing of Implementation

Refer to attached drawings regarding Hoofddorp, Rotterdam West and Rotterdam Lombardijen (appendix 7.5 - 7.7)

3.6 Implementation concept

Interlocking and wayside Modification

The implementation of the necessary modifications indoor and outdoor does not form any problem. Software changes of the conventional sections could be made during weekends. The level of modification is considered low, without major risks for implementation.

3.6.1 Phases of implementation

The implementation of the all modifications will be made in a one-step approach, section by section.

As a projection change is required at each section, the projections at Hoofddorp and Rotterdam of the SIMIS-C installations are affected. Normal lead time of the supplier (Siemens) is at least 9 months. Also at the border crossing on the Belgian side are modifications required. The implementation time is unknown.

3.6.2 Implementation risks

No major risk for the technical implementation has been identified. Further simplifications are possible for short periods of operation such as cancelling of the key release instrument by sealing the key in the operator room for all points, application of dummy announcing signals also for the normal direction of traffic by reducing the speed to e.g. 80 km/h. Such further simplifications will have to be discussed and agreed at a later stage, if necessary, but should not be the starting point for an alternative solution to the ERTMS. However, any further simplification could only be acceptable for a very short period in agreement with the safety department.

The interface with the Block control and supervision function at interlocking and OCC (Operational Control Centre) is identified as a potential risk. The modifications needed are not standard and should be designed. Solutions to modify automatic Signal operation at the entrances should be made and accepted.

3.7 Safety Acceptance

No change of generic software is expected. All modifications are standard applications. However, a new safety assessment and safety approval including a revision of the safety case for the temporary application is required. From a technical point of view, the safety of signaling is one aspect, the overall safety case will have to consider also the deficiencies regarding the compromised tunnel protection, the missing control and supervision of the changeover of traction power, the missing CC system and the reduced safety level of the point protection on the HSL section. However, for a limited period of operation, the deficiencies should be tolerable. Mitigations by employing a second train driver on each train and shorter inspection periods for signal installations should be applied.

3.8 Training

No particular training for the system modifications is required. A very profound training for the train drivers to respect signal aspects and train speeds is necessary. The staff schedule must consider additional drivers (second driver) and operating pattern.

3.9 Testing

After completion of works, a complete test of all modifications is necessary. For the de-commissioning of the signal and block system in future, a retest of the initial software and hardware is required.

3.10 Maintenance

No particular requirement, inspection periods of mechanically locked turnouts must be maintained.

3.11 Future de-commissioning

The “No-CC “ solution as well as all Class B CC solutions can be considered as temporary solution until ERTMS is ready for operation. Distant signals and point locking does not form any major problem for the later transfer from No-CC solution to the ERTMS and the decommissioning of the installed temporary devices. The key problem will be the return from one block section and *section to section block* to multiple ERTMS block sections between the conventional sections and the necessary re-testing while revenue service has already started.

3.12 Operational rules to be implemented

Operational rules will have to be defined and implemented regarding speed restrictions, changeover of traction power, additional train driver organization, reversing of emergency cross over in cases of emergency and access to branch lines.

3.13 Rolling Stock

There are no particular requirements for Rolling Stock.

3.14 Time Line

"No CC"	Year 1												Year 2								
	Start	Month												Month							
		1	2	3	4	5	6	7	8	9	10	11	12	1	2	3	4	5	6	7	8
Design Level 1 & 2	■	■	■																		
Design Level 3		■	■	■	■																
Procurement		■	■	■	■	■	■														
Installation				■	■	■	■	■	■	■											
Testing & Commissioning									■	■	■	■	■								
Safet Assessment				■	■	■	■	■	■	■	■	■									
Safety Approval											■	■	■	■							

Table 5 - Time schedule "No CC system"

It should be noted that the time schedule is very tight and an involvement of all concerned parties from the beginning on is important. Supply of materiel within the scheduled time frame is only possible when existing material from the stock can be used or rented from other railway administration. The normal way of the supply chain from ordering, production, delivery is not feasible within this short time frame.

3.15 Costs

Description	Quantity	Cost/Unit (T€)	Cost (T€)
Signals Indoor & Outdoor*	7	40	280
Cables	5	10	50
CBI Modification	2	30	60
Key release	2	10	20
Point clamps	30	3	90
Block	2	150	300
Tunnel protection Unit	2	50	100
Software Modif	2	60	120
Testing	1	100	100
Safety Approval	1	150	150
Sub-total 1			1.270
Design Engineering	16%		203
De-Commissioning	10%		75
Testing De-Commissioning	50% of initial Testing		50
Total "No CC"			1.598
Contingencies	10%		160
Grand Total "No CC"		approximately	1.800

Note * - Including tunnel protection

Table 6 - Costs "No-CC system"

The cost estimation is based on standard figures with known risks for implementation. It is not possible to achieve competition for the majority of the works and therefore the costs might increase from 20 to 30 % due to suppliers' sales strategy.

3.16 Evaluation

Time Schedule for Implementation

The implementation is expected to be ready within a period of one year with an addition of one month for the final acceptance and trial run as necessary for the final safety approval and acceptance certificate. A mutual understanding of all involved parties is essential for the implementation of the project. Material, signals, cables etc will have to be taken from store, other projects or other railway administration. By applying the normal procurement procedures the time frame would have to be extended to two years.

Safety

The safety of the signaling system itself can be achieved with a Safety Integrity Level SIL 4 regarding the technical implementation. However, the overall safety is compromised due to the missing Control Command system, which is mitigated by speed limitations and a second driver.

Homologation Train

Not applicable

Safety Acceptance Line

Safety acceptance by the safety Authority should be possible for a limited period.

Other safety aspects

Tunnel / water barrier protection can be made by additional protection signals. Control of traction power switching is not feasible.

Performances

Speed

It is proposed to reduce the speeds to 140 km/h maximum.

Headways

Due to the requirement of one train between adjacent conventional sections, the headway is significantly reduced.

Operation

The immobilization of the emergency crossovers on the HSL line does not form an operational bottleneck and can be easily accepted for a limited period. The immobilization of the branch line connections to Breda and Zevenbergschen Hoek does significantly reduce the operational acceptance by the public.

Costs

Costs for train sets

Not applicable

Costs for Line equipment

With approximately 1.76 million € the costs are reasonable.

Risks for Implementation

No major risks beside the management of supplies works and interface with the Operational Control Centre.

Commissioning

No risk

De-Commissioning

No risk

4 ATB-NG

4.1 Introduction

The ATB-NG can replace the speed and brake supervision of the ERTMS system under certain conditions. The conditions are:

- Implementation of distant signals to home signals for normal and reverse direction.
- Forming entrance-to-exit section to one block section permitting only one train per track between the entrance and exit of the conventional line.
- To clamp the switches of the cross over and turn-outs in straight direction.
- Limit the speed to 160 km/hr in order to drive on signals.

Specific items to regard for the implementation are the interface with the interlocking system of the conventional line and the modification of the equipment in the Rolling Stock.

4.2 ATB-NG functionalities

The ATB-NG system performs the following functions:

- Verification of the vigilance and correct response of the train driver to the signal aspect and triggering the emergency brake in case the train driver does not confirm the recognition of a warning aspect of the announcing signal.
- Supervision of braking of the train in front of the stop aspect of a main signal by continuous supervision of the brake process.
- Triggering of the emergency brake in case of overrunning a stop aspect.
- Supervision of speed restrictions and triggering emergency brake in case of intolerable speeding;
- Supervision of maximal train speeds and triggering emergency brake in case of intolerable speeding.
- Presentation of the braking curve to the train driver.
- Presentation of the speed to be achieved at the presented distance.
- Data entry to enter specific train data (Max. speed, length, number of axles without brakes).

The ATB-NG system consists of a wayside installation and a train borne equipment. The maximum speed for which ATB-NG can be applied in the Netherlands is 160 km/h.

4.3 Implementation concept

4.3.1 General aspects

The ATB-NG system consists of balises between the tracks. Each balise is transmitting a message. The message can be made dependent to the next signals. The antenna of the passing train detects the message. The ATB-NG train-side equipment processes the message and compares continuously the calculated braking curve with the actual speed, forwards the information to the train driver and acts if necessary by giving warning signals or braking the train.

A wayside central cabinet controls the balises. This cabinet contains one amplifier/transmitter unit per balise, encoder units, central processing unit (CPU) and input units. The cabinet is power supplied by BX/NX 110V and BX/NX 28V.

Cabinets with balises that transmit a message dependent of signals are connected to the interlocking system to obtain information of the allowed speed at the next signal and beyond.

4.3.2 Balise

An ATB-NG balise is an antenna between the tracks and is mounted left from the centre. The antenna is connected to a cabinet beside the track by cable (3x2,5 mm²). The maximum distance between amplifier and antenna is 1000m. The maximum distance between two balises is 5.500m.



Image 7 - ATB-NG balise (antenna)

4.3.3 Way side equipment

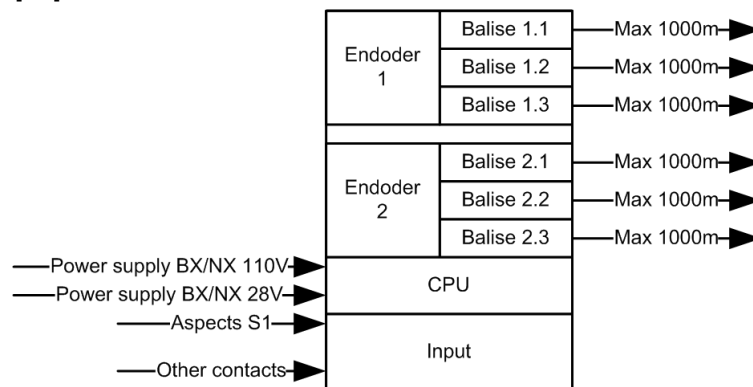

Image 8 - ATB-NG Cabinet

The maximum configuration of a standard cabinet is 2 encoder units and 6 amplifier units. As a result a cabinet can handle a maximum of 6 ATB-NG balises. Each cabinet needs power supply. If connected balises should transmit messages that dependent on a signal, also aspect inputs are necessary.

4.3.4 Typical system configuration

The principal layout of ATB-NG is shown below. The driving direction is towards signal S1.

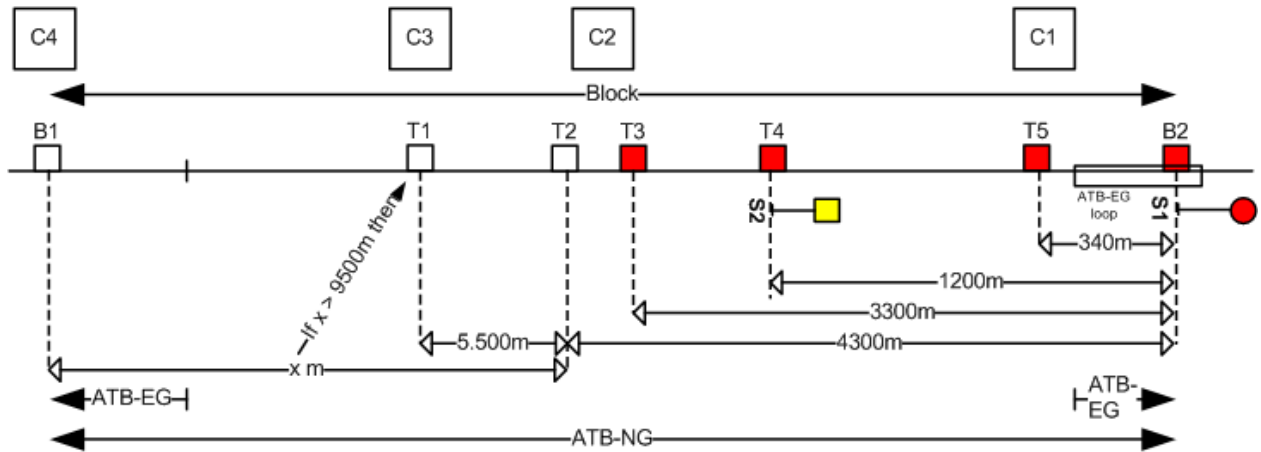

Image 9 - Principle layout ATB-NG

The balises T3, T4, T5 and B2 are related to the home signal S1. The transmitted messages of these balises depend on the status of the home signal S1. The balise T3 is used to transmit changes in the signal S1 (aspect improvements). The balises B1, T1, and T2 are transmitting fixed messages. The distance between balise and cabinet is limited. Therefore several cabinets (Cx) are necessary along the track. The ATB-NG is switched on at balise B1 and switched off at balise B2. The ATB-EG is only active if the ATB-NG is switched off.

4.3.5 Supervision of speeds on the line

The ATB-NG system supervises the maximum speed of the train and can also supervise fixed speed restrictions on the line. The tunnels are not protected by signals except the “Groene Hart Tunnel” (see chapter 3.2.8). In case of a tunnel in calamity there is no possibility to stop the train automatically. The ATB-NG system offers the possibility to reduce the speed or to activate the mode “Driving on sight” if the tunnel is in calamity. A signal from the tunnel is connected to the ATB-NG input unit. When activated the concerning balise will transmit the message and warn the train driver.

This warning system can also be used for the water barriers (tunnels south section). The water barriers on both sides of the tunnel can be included in the signal protection and accompanying ATB-NG system. In this case the signals have to be located in front of the barriers.

4.4 Description of Main Interfaces

4.4.1 Overlay ATB-NG / ATB-EG functional relation

The ATB-NG system and the ATB-EG system are not simultaneously in operation. The transition from ATB-EG to ATB-NG takes place at the first balise. The first ATB-NG balise shall be positioned before the last isolating joint of the GRS train detection. The transition from ATB-NG to ATB-EG takes place at the last balise. Before the last balise the ATB-EG code shall be present to activate the ATB-EG system. The ATB-EG code is transmitted by a loop.

4.4.2 Interlocking and Signals

The ATB-NG input units form the interface between the encoders and the interlocking. In the Netherlands only contact inputs are used. The input signals are used to determine all possible aspects and to control which message is transmitted.

The system can provide lamp current inputs. However, these units are not applied in the Netherlands. The presence of flashing aspects is probably one of the reasons that lamp current is not applied.

HSL-Zuid connects to the existing conventional line at five locations. At these points, the electronic interlocking system (EBS, SIMIS-C) of ProRail is linked to the interlocking system of HSL Zuid. The exchange of information (commands and messages) is performed by hardwired input and output modules. The conventional line uses adapted ARELA Relay boards for this purpose.

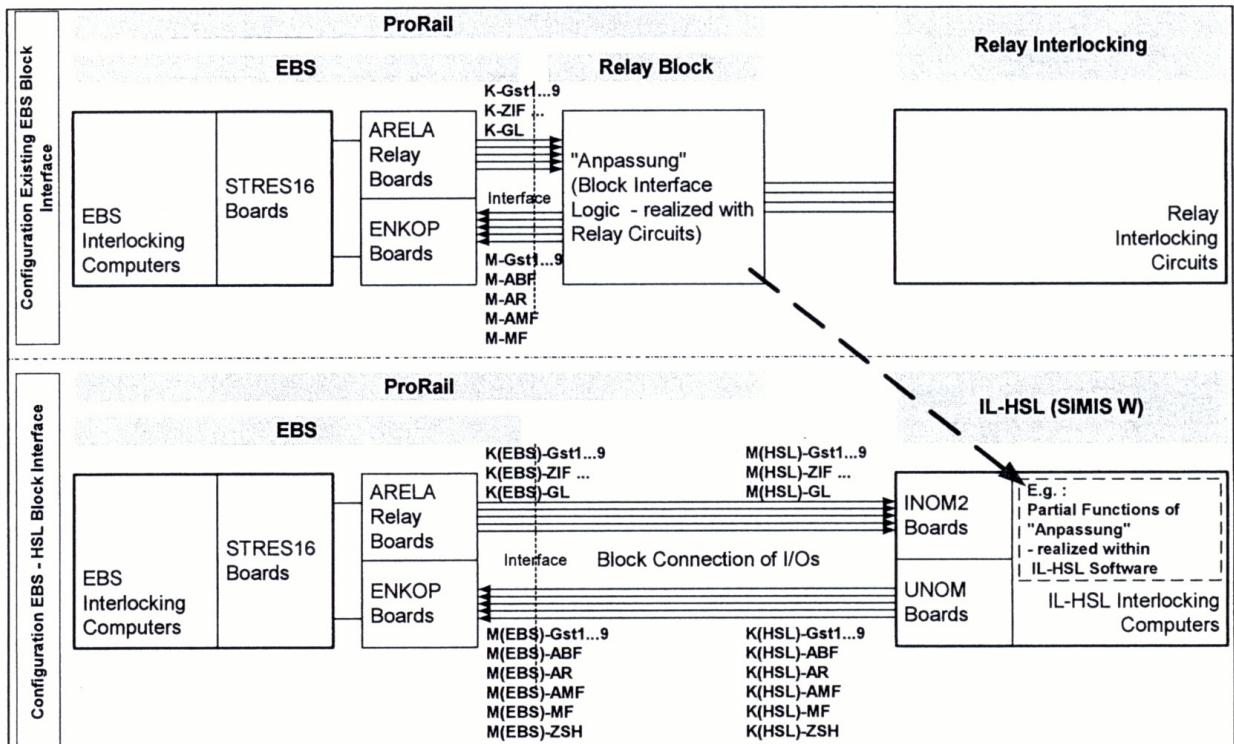

Image 10 - Interface interlocking conventional line and HSL Zuid

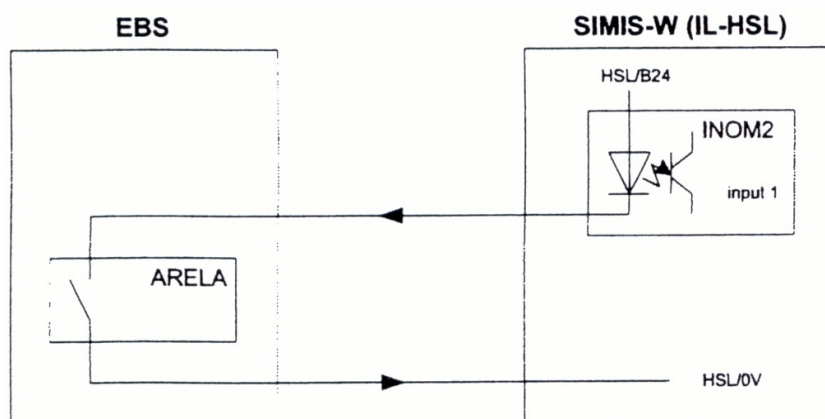

Image 11 - EBS command to HSL Zuid

The command signal “Gst” from EBS to HSL contains information about the allowed speed at the exit signal and beyond. In fact this information contains the information of the aspects. It is likely that the same signals can be used as input for the ATB-NG. If not, small modifications in the program have to be implemented to use this Relay board.

4.4.3 Power Supply

The BX/NX 110V and BX/NX28 power supply is normally taken from the 3kV power supply system of the conventional network. In the transition zones these power supply signals are already present. To supply all ATB-NG cabinets the existing 3kV, 110V and 28V power supply system has to be extended.

4.4.4 EMC considerations

According to ProRail the ATB-NG system is compatible with 25kV. Special attention must be paid to the connecting cables.

The ATB-NG system however is not used at the moment on 25KV tracks. The system is mainly used on diesel tracks.

4.4.5 Environment

The ATB-NG and power supply cabinets have to be placed beside or near the track. Safe working, maintainability, accessibility, in- and outgoing cables shall be taken into account. Because of the concrete pavement special attention shall be paid to the mounting structures.

4.4.6 Alternative implementations

The implementation costs can be reduced if the ATB-NG cabinets can be power supplied locally. The standard power supply of the ATB-NG cabinet has to be modified or extended with a voltage transformer unit to achieve this. The development of a reliable alternative power supply will take some time.

The implementation costs can also be reduced by not implementing ATB-NG between the Belgium Border and the distance signal at the Rotterdam entrance. Trains will run in without speed protection on this part.

The above mentioned alternatives will not reduce the time schedule. The alternative implementations need more investigation to determine the feasibility and are not included in the cost calculations.

4.5 Required modifications

4.5.1 Interlocking and signals

For each entrance to the conventional line a signaling interface has to be build using the existing speed commands from EBS to HSL using the existing cable distributor of the ARELA5 relay board. The SIMIS/W interface will be replaced by an ATB/NG interface. The EBS commands are connected to the ATB-NG input units by cables. It is likely that the commanding contacts have to be multiplied because the EBS commands have to be used in more than one ATB-NG cabinet. It is assumed that this will be done by B-Relays. The new EBS/ATB-NG interface is connected to the cable distributor. The interface with HSL will be disconnected.

4.5.2 Cable Infrastructure

For the EBS interface low-voltage cables have to be laid from the EBS room to the ATB-NG cabinets. For the power supply a 3kV cable has to be laid to the high voltage cabinets near the ATB/NG cabinets. From the 3kV cabinet to the ATB-NG cabinet low/voltage power supply cables have to be laid. It is assumed that the existing cable ducts and cableway can be used.

4.5.3 Power supply

The existing 3kV power supply network has to be extended to power the ATB/NG cabinets. Near an ATB-NG cabinet (or group of cabinets) a high voltage cabinet should be installed. The high voltage cabinet contains a transformer 3kVAC 75Hz to 110VAC 75 Hz and 28VAC.

4.5.4 Way side modification

The ATB-NG system can be installed besides the existing system. Modifications of the way side HSL equipment is not foreseen. The ATB-NG and power supply cabinets however must be placed beside or near the track. Because of the concrete pavement, noise reducing walls and the large amount of viaducts modification of the structures are likely or special mounting frames have to be build.

4.5.5 Installation constraints

The ATB-NG balises and ATB-NG cabinets have to be installed according to the ProRail regulatory requirements. Special attention must be paid to cabling and EMC.

ATB-NG cabinets must be installed along or near the track. The maximum cable length between balise and cabinet is 1000m. Around the ATB-NG cabinets enough space must be present to walk around and to open the front and back doors.

High voltage cables and low voltage cables shall be laid separately.

4.5.6 Schematic drawing of implementation

The schematic drawing of ATB-NG implementation on HSL Zuid is provided in **appendix 7.4**.

4.6 Commissioning and testing

4.6.1 Safety Approval

The ATB-NG system is approved for the Dutch railway and described in the ProRail regulatory requirements. The EBS/ATB-NG interface can be build according to the existing ProRail regulatory requirements.

4.6.2 Training

Training is required for the concerned train drivers and maintenance personnel. All Training programs are available.

4.6.3 Testing

For testing purposes of the installed balises transportable test units are available. Each possible message the balise can transmit has to be tested on site in relation to the input signals. ATB-NG cabinets including all ATB-NG equipment and programmed messages shall be tested in the factory and on site.

4.6.4 Maintenance

The ATB-NG balise is maintenance free. The ATB-NG cabinets need regular inspection. In case of failure electronic equipment must be exchanged, reset and tested. For this purpose all cabinets must be accessible during operation of the line.

4.6.5 Future De-commissioning

No particular obstacle for the future transfer to ERMTS is foreseen. Since the ATB-NG uses the EBS-HSL interface this interface had to be restored and tested.

4.7 Costs

Description	Quantity	Cost/Unit (T€)	Cost (T€)
EBS interface	2	150	300
ATB-NG cabinets	12	12	144
Encoders	18	18	324
Balises	34	8	272
HS cabinets	12	16	192
LV cabinets	12	9	108
km High Voltage cable	45	40	1.800
km Low voltage cable	15	10	150
Commisioning & Testing	1	230	230
Sub-total 1			3.520
Design / Engineering	16%		563
De-commissioning	10%		352
Testing De-commissioning (50% of initial testing)			115
Total ATB-NG NORTH			4.550
Contingencies	10%		455
Grand Total ATB-NG NORTH		approximately	5.000

Table 7 - ATB-NG Trackside Assembly Costs - NORTH

Description	Quantity	Cost/Unit (T€)	Cost (T€)
EBS interface	1	150	150
ATB-NG cabinets	11	12	132
Encoders	13	18	234
Balises	25	8	200
HS cabinets	11	16	176
LV cabinets	11	9	99
km High Voltage cable	46	40	1.840
km Low voltage cable	11	10	110
Commisioning en testing	1	250	250
Sub-total 1			3.191
Design / Engineering	16%		511
De-commissioning	10%		319
Testing De-commissioning (50% of initial testing)			125
Total ATB-NG SOUTH			4.146
Contingencies	10%		415
Grand Total ATB-NG SOUTH		approximately	4.600

Table 8 - ATB-NG Trackside Assembly Costs - SOUTH

Description	Quantity	Cost/Unit (T€)	Cost (T€)
No-CC system - NORTH & SOUTH	1	1.800	1.800
ATB-NG - NORTH	1	5.000	5.000
ATB-NG - SOUTH	1	4.600	4.600
Grand Total ATB-NG & "No CC"		approximately	11.400

Table 9 - ATB-NG incl. No-CC Trackside Assembly – Total Costs

4.8 Schedule

The implementation of “No CC” as described in chapter 3 is required as a precondition for the installation of ATB-NG. The necessary activities to install and commission “No CC” have been described. The schedule for installation and commissioning of ATB-NG does consider that “No CC” will be established in parallel to ATB-NG.

ATB-NG + "No CC"	Year 1												Year 2												
	Start	Month												Month											
		1	2	3	4	5	6	7	8	9	10	11	12	1	2	3	4	5	6	7	8	9	10	11	12
Gathering information	■																								
Design		■	■	■	■																				
Detailed design				■	■	■	■	■																	
Programming and check CPU																		■	■						
Ordering equipment								■	■	■	■	■	■	■	■	■	■	■	■						
Installing equipment																		■	■	■	■	■	■		
Testing and commissioning																							■	■	

Image 12 - Schedule ATB-NG Trackside Assembly

4.9 Implementation Risks

All implementation risks of the No-CC system are applicable. The following additional implementation Risks are identified:

- Availability of suitable location for ATB-NG cabinets and power supply cabinets
- Acceptance of ProRail to use ATB-NG on 25kV tracks
- Delivery times
- Design time of interface with conventional interlocking system
- Installation of cabinets at locations which are difficult to access

4.10 Rolling Stock

The only interface with Rolling Stock is the transmitting antenna between the tracks. The ATB-NG receiver antenna on the train picks up the transmitted message of the balise.

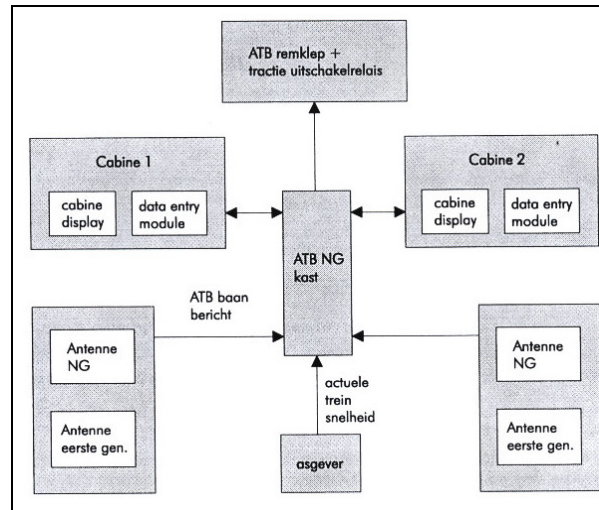

Image 13 - Interface ATB-NG / Rolling Stock

4.10.1 BR 186 and 189

The locos BR 186 are all mounted with ATB-EG as an STM (Specific Transmission Module) for the EVC (ETCS). Also the locos class 189 are equipped with a single device ATB-EG in addition to the other train protection modules on this loco.

The ATB-NG is a closed system and it is homologated as a closed system. To install ATB-NG as a complete system on the loco BR 186 or 189 several modifications have to be done on the locos.

4.10.1.1 Required modifications

For the integration of ATB-NG in the loco BR 186 or 189 two solutions are possible:

- a) Integrated solution within 1 display and in addition the integration of parts of the loco in the ATB-NG system
- b) Isolated solution with separate display for ATB-NG and using all the original parts of the ATB-NG system

Solution a) is more complex regarding development, integration and homologation. In total a time of at least 24 - 30 months are estimated.

Due to time constraints for commissioning of HSL Zuid, only solution b) is the preferred solution.

The main components of ATB-NG on the train are:

- Unit for data entry
- Juridical recorder
- Speed indicators
- Display

Further components are antennas, ATB rack and cable connections.

The ATB cab display has to be installed in the area of the driver. This is possible as shown in the following picture below. The requests from UIC about the sight for the driver are fulfilled.



Image 14 - Drivers desk loco class 186 or 189 with ATB-NG cab display

Furthermore the panel for data entry has to be installed in the backside of each cabin or once in a electronics cabinet in the engine room. The juridical recorder and the new ATB-NG rack have to be installed as well.



Image 15 - Data entry for ATB-NG



Image 16 - Juridical recorder for ATB-NG

Outside of the loco the antennas with new developed antenna holders have to be installed, one on the front bogie and one on the back bogie. The speed indicators on the axles have also to be mounted new. All these parts of the equipment have to be connected with cables. The time to build in the ATB-NG is round about 6 - 8 weeks after a development time of approximately at least 6 months.

The availability of mounting space for additional antenna's and speed indicators on the Rolling Stock has not been investigated.

4.10.1.2 Homologation

The new fit in parts of the ATB-NG has to be homologated together with the new cables and their integration in the loco. For this homologation it is obligatory to perform test runs with the loco for approximately 4 weeks. In addition the loco has to be tested regarding compatibility of ATB-NG and the traction motors of the loco, the interferences and so on. This will also take 4 - 6 weeks.

For testing and homologation a time of 6 months is estimated.

4.10.1.3 Costs

The costs for the homologation and the test runs are approximately 250 T€. The costs of the parts of the ATB-NG and to build in this equipment are approximately 400 to 450 T€. The single costs for the development come up to roundabout 750 T€.

4.10.1.4 Potential risks

Risks are here the possibility of the influence for interferences of the traction motors or convertors.

4.10.1.5 Recommendations

To equip the loco class 186 with the ATB-NG is complicated, time consuming and expensive. It will take a time of roundabout 12 months. It is not the best solution to use it for only 2 or three years.

Time and costs conclusion:

Time

months	1	2	3	4	5	6	7	8	9	10	11	12
BR 186 / 189	Development						Implementation	Test Runs		Homologation		

Table 10 - Timeschedule ATB-NG Rolling Stock BR 186/189

Costs

T Euro	50	100	150	200	250	300	350	400	450	500	550	600	650	700	750	800	850	900	950	1000
BR 186 / 189	Development															Homologation			Test Runs	
BR 186 / 189*	Implementation																			

* single costs per loco

Table 11 - Costs ATB-NG Rolling Stock BR186/189

4.10.2 Thalys

The Thalys train sets PBKA are equipped with ATBL train protection. This device is good for ATB-EG and NG and TBL. ATBL of the Thalys train sets are up to now not used on tracks with 25 kV voltage. Regarding Thalys PBA: To build in an ATB-NG in train sets is the same procedure as for locos (e.g. BR186). Train sets only need one ATB rack and one juridical recorder in each head; locos need only one per loco. The equipment in the drivers cab is the same. The time and the

single costs are nearly the same; the costs per train set are round about 100 T€ higher. The costs are determined per trainset (containing 2 cabs per train, antenna's and odometry).

4.10.2.1 Required modifications

For the PBKA train sets the integration of ATB-NG into the new cab display for ETCS has to be developed. This will take minimum 6 months.

4.10.2.2 Homologation

The ATBL of the Thalys PBKA train sets has to be homologated on HSL Zuid under 25 kV. For this homologation it is crucial to perform test runs with the train set for round about 2 -3 months. Additionally it is also required to homologate the indication of the ATB-NG in the displays of the train sets, because all train sets are equipped with two displays for the ERTMS/ETCS migration and the original cab display will be replaced by a Bi-Standard DMI. Including the elaboration of the necessary documents the whole homologation will take a time of round about 6 months.

4.10.2.3 Costs

The costs for the test runs, creating the needed documents are round about 400 - 500 T€, the costs for the homologation are round about 200 T€.

4.10.2.4 Potential risks

Risks are here the possibility of the influence for interferences of the 25 kV line voltage and the function of the antennas for the ATB.

4.10.2.5 Recommendations

ATB-NG is a better solution for the Thalys in comparison with BR 186. At least 6 months time are required for integrating the ATB-NG functionality into the DMI and the needed tests, the homologation process take a time of 2 months.

Time for implementation ATB-NG in PBA and DMI-Development

months	1	2	3	4	5	6	7	8	9	10	11	12
Thalys, PBA	Development ATB-NG						Implementation	Tests			Homologation	
Thalys, DMI*	DMI-Integration, Development, Tests						Tests			Homologation		

* The required DMI-Integration is applicable for both Thalys PBA and PBKA

Table 12 - Time schedule ATB-NG Rolling Stock Thalys, PBA & DMI-Integration

Costs DMI-Integration

The DMI Integration concerns only software. Therefore the following costs cover the complete fleet of Thalys PBKA. The costs to implement the (approved) software are negligible.

T Euro	100	200	300	400	500	600	700
Thalys, DMI*	DMI-Integration, Development, Tests					Homologation	

Table 13 - Costs Thalys, DMI ATB-NG

Costs ATB-NG in PBA

T Euro	50	100	150	200	250	300	350	400	450	500	550	600	650	700	750	800	850	900	950	1000
PBA, single costs	Development & Tests															Homologation				
PBA, per trainset	Implementation																			

Table 14 - Costs ATB-NG in Thalys, PBA

5 Alternative Signaling with PZB as CC system

5.1 Introduction

Various protection measures and interlocking modifications are necessary in order to permit the function of a Class B CC system. Such measures are

- Implementation of distant signals to home signals for normal and reverse direction
- Protection of emergency cross-overs and branch line connection on the open line
- Forming the station-to-station section to one block section permitting one and only one train per track between two stations.

Those issues are the same as for the solution without CC system and are described in more detail in chapter 3.

5.2 Brief Presentation of PZB functionalities

The PZB (German Acronym “Punktförmige Zugbeeinflussung”) is based on the former Control Command System “Indusi” and performs the following functions:

- Verification of the vigilance and correct response of the train driver to the signal aspect and triggering the emergency brake in case the train driver does not confirm the recognition of a warning aspect of the announcing signal within 4 seconds (for newer trains the delay is 2.5 seconds).
- Supervision of braking of a train in front of the stop aspect of a main signal by continuous supervision of the brake process
- Triggering of the emergency brake in case of overshooting a stop aspect
- Supervision of speed restrictions and triggering emergency brake in case of intolerable over speeds
- Supervision of maximal train speeds and triggering emergency brake in case of intolerable over speeds

The PZB system consists of the wayside installation and the train borne equipment, the latter is described under the Rolling stock chapter.

The INDUSI and PZB are applied in Austria, Germany, Romania, Serbia, Croatia, Israel and Slovenia at line length in total of more than 70 000 km.

The maximum speed for which PZB can be applied is limited to 160 km/h.

On board the locomotive are active oscillating circuits tuned to the frequencies of 500, 1000 and 2000 Hz. The passive oscillating circuit is installed trackside as

- 1000 Hz Balise at the warning signal
- 2000 Hz Balise at the main signal
- 500 Hz Balise in 150 – 250 meter distance to the main signal and 450 m distance to the first danger point behind the main signal

While passing the Balise, the train borne system receives the corresponding frequency selective influence and processes the information accordingly.



Image 17 - PZB Track Balise

Arrangement of PZB Balise on the rail - example for DB

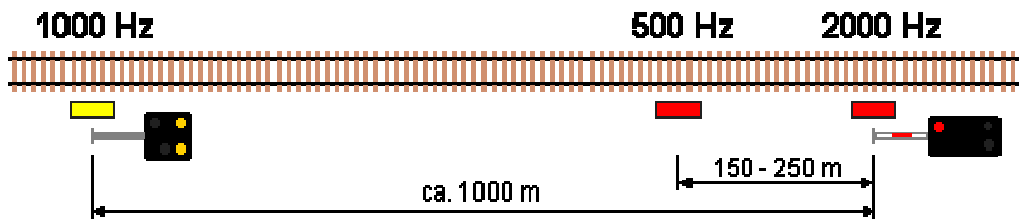

Image 18 - PZB Concept

5.2.1 Function of PZB

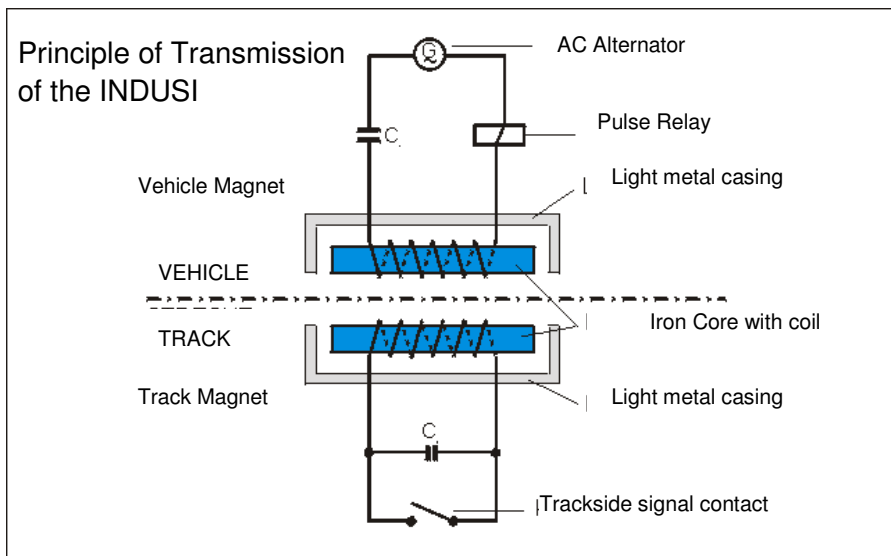

Image 19 - Schematic principle of transmission via PZB / Indusi

1000 Hz Balise

The Locomotive receives the 1000 Hz information while passing the distant signal at warning aspect. After receipt of the 1000 Hz information, the train driver has 4 seconds to confirm otherwise an irreversible emergency brake will be triggered. Within 23 seconds, the train driver will have to reduce the speed down to 95 km/h. In addition to the time function a passed distance function is active, which checks that the 95 km/h speed is respected after a distance of 1250 meters has been passed. After a distance has been passed of 700 meters, the train driver might release the train from the speed monitoring by manual intervention, thus permitting the train driver to proceed in

case the main signal, which is visible from that distance, has changed in the meantime to a proceed aspect.

The PZB uses relative position information, determined by odometry, which is measured from the recently passed distant signal. Thus, the position of the train is calculated only when braking to target.

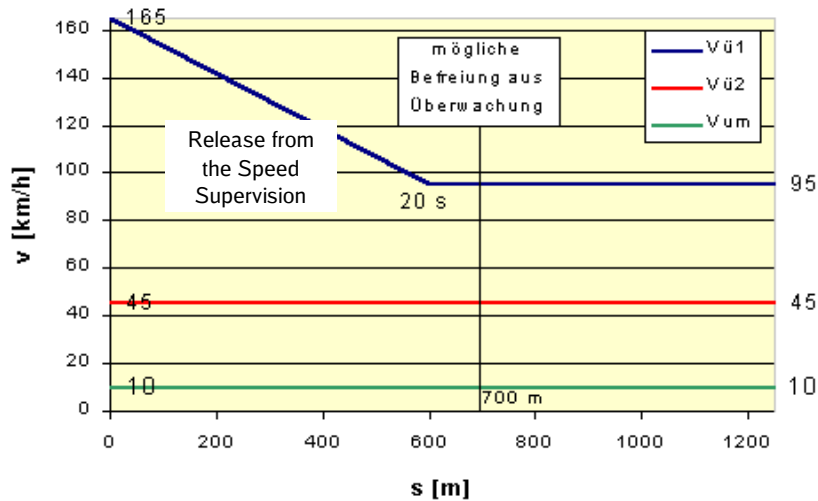

Image 20 - 1000-Hz-Speed Supervision

500Hz

The 500 Hz information triggers also a continuous speed monitoring. While passing the 500 Hz Balise when the main signal shows danger aspect, the speed must be less than 65 km/h. Within 153 meters, the speed must have been reduced to 45 km/h. The speed will be supervised up to 250 meters beyond the 500 Hz Balise. The 500 Hz Balise is an additional safety feature in order to ensure that a train driver cannot issue wrongly the release command from the 1000 Hz and increase the speed in front of the danger signal.

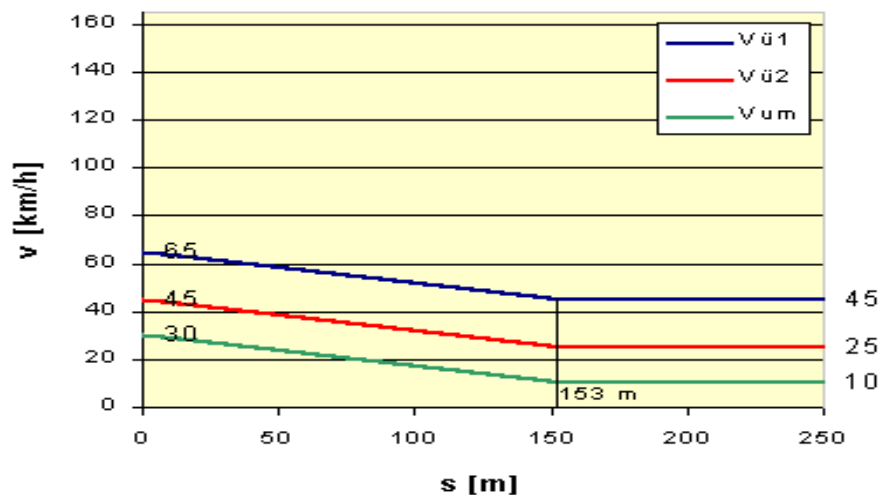

Image 21 - 500-Hz-Speed Supervision

Please note, the additional values for 45 and 30 km/h are related to slower trains operating in other operating modes.

2000 Hz

Immediately an irreversible emergency brake will be triggered when passing the 2000 Hz Balise at signal danger aspect.

5.2.2 PZB Protection of danger points for starting trains from platforms

The PZB includes a function so called “Restrictive Speed Check” that checks the maximum speed after a train stop at a platform in order to ensure that a train cannot approach the starter signal at higher speed when the starter signal shows danger aspect. This function is embedded in the PZB system but not required for HSL Zuid because the ATB-EG takes over the CC function within the boundaries of conventional sections.

5.2.3 PZB Protection of sections with reduced speed

The PZB can be used for the supervision of speed restrictions on the line and for temporary speed restrictions as well. Speed restrictions of 90 km/h and less will be ensured by a permanent active 1000 Hz Balise.

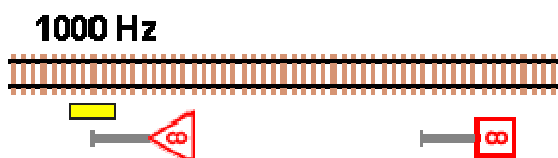

Image 22 - 1000 Hz Balise

Speed restrictions above 90 km/h will be ensured by activation of a 2000 Hz Balise for a predefined time slot. The activation is made at a certain distance to the 2000 Hz Balise according to the speed to be supervised. When the train is too fast, it will pass the 2000 Hz Balise while the Balise is still active.

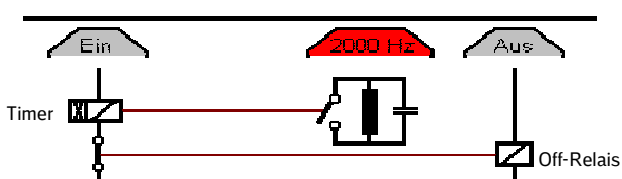

Image 23 – 2000 Hz Switch

The functions are not required for HSL Zuid, because no speed restrictions exist on open lines. However, temporary speed restriction may occur and therefore the system could be implemented

5.2.4 Supervision of Maximal Train speeds on the line

In case the train exceeds a maximum speed of 165 km/h, the PZB triggers an emergency brake until the speed of the train is below the speed of 165 km/h.

The supervised speeds and brake trigger points mentioned above are different for the various types of trains at DB. For the application on HSL Zuid, only the values above corresponding to a train in operating mode “O” are relevant. Other values are applicable for trains at lower speed.

5.2.5 Tunnel Protection / Water Barriers

The tunnel protection (including water barriers) is required in order to inhibit train movements into tunnel section when the tunnel supervision system indicates alert status. The PZB system is not an independent protection system, which could be applied for tunnels. Reference is made here to the “No CC” solution, where three possibilities have been explained. PZB can support the tunnel protection, if protection is made by individual signals on the HSL line. The proposed solution is to inhibit departures from conventional lines into HSL lines, when a tunnel or water barrier on the HSL line is in alert status. For this application, the ATB_EG system will support the protection system. For the Boor tunnel of 7.82 km length, it is proposed to apply special tunnel protection signals. These signals will be equipped with 1000 Hz and 2000 Hz Balises in order to stop a train in case of tunnel alerts. The 500 Hz Balise can be deleted for this application. However, it should be noted that the proposed solution of tunnel protection must be assessed about the tolerable risk level, which is beyond the scope of this study. A separate safety assessment is necessary because the use as support for tunnel protection is not the native environment of the PZB system.

5.2.6 Control and Supervision of Traction Power Switching

Traction power switching is out of the PZB solution and must be covered by procedures. The train system itself is protected against erroneous switching.

5.2.7 Comparison of the native application with HSL Zuid

The application at DB and the intended application on HSL Zuid are very similar. The distance between distant signal and home signal is 1000 m at DB and 1200 m on HSL Zuid.

Overlaps do not exist on HSL Zuid in the same form as at DB, however, safety distances of 200 m to danger points are respected for the specific application.

The PZB does not control speed limits at all levels beyond home signals, however specific solutions can be applied such as permanent or route selective active 500 Hz Balise for supervision of 60 km/h (emergency brake at 65 km/h) or permanent active 1000 Hz Balise for the supervision of 80 - 90 km/h (emergency brake at 95 km/h) or the application of specific slow speed supervision section.

During the detail design phase the optimized distance of the 500 Hz Balise to the main signal will be simulated. This distance could be slightly increased due to the longer distance between distant signal and home signal and the different braking curves compared to DB.

A minor adaptation of the design rules at HSL compared to DB is recommended, but this is of minor significance for the safety acceptance of the system.

5.3 Description of Main Interfaces

5.3.1 Overlay PZB – ATB-EG – functional relation

Refer also to Rolling Stock Chapter

PZB and ATB-EG are activated simultaneously. On the line, the Train will receive the PZB information whilst approaching signals at danger aspect or signals indicating a reduced speed. The train driver is not influenced by the PZB when signals are not restrictive or when no PZB Balises are applied e.g. Starter signals, which are covered by the ATB-EG system.

5.3.2 Interface PZB – ATB –EG EMC considerations

PZB Balises will be installed outside the conventional sections where no ATB-EG sections are installed. In addition, both systems are working in completely different frequency ranges that interferences from one system to the other can be excluded. Nevertheless, practical EMC test are recommended.

5.3.3 Interface PZB – Interlocking / Signals

No interface PZB Interlocking

PZB – Signal interface is made by the signal filament /LED control circuit

5.3.4 Interface PZB – Power supply

No interface

5.4 Required Modification

5.4.1 Interlocking and signals

The PZB system is based on the speed supervision and brake control in a braking distance to the main signal. Therefore, the PZB requires the installation of distant signals in the braking distance to the main signal. The PZB has no interface to the interlocking system itself. The information of the signal aspects will be gathered directly from the signal control circuit on site. Standard interfaces exist for this connection

5.4.2 Cable Infrastructure

For the distant signal, a new cable must be laid from the nearest cable distributor to the signal position.

For PZB, cables of type 2 x 2 0.75 mm² shall be used. The cables will be terminated at the signal control unit. The 500 Hz Balise will be connected to the home signal control unit. The cable might be laid and fixed on the base of the rails in case no cable duct is available

5.4.3 Power Supply

The distant signal should be applied in LED technology thus permitting low power consumption. The spare capacity of the interlocking supply should be sufficient to supply the new additional distant signals.

The PZB Balises are passive elements and need no power supply.

5.4.4 Installation constraints

The trackside Balises have to follow the positioning of the train borne antenna at the outer side of the track in running direction. The distance to the signal is defined with a tolerance of +/- 6 meters thus permitting an installation outside the ATB-EG track circuits of the conventional sections.

The Balises are normally fixed on supports clamped to the rail and can be installed on slab tracks.

5.5 Schematic drawing of implementation

See appendix 7.5, 7.6 and 7.7.

5.6 Implementation concept

5.6.1 Wayside Modification

None, except the connection of the Balises to the signal control unit

5.6.2 Phases of implementation

It is obvious that the additional distant signal must be implemented prior to the installation of the Balises. No particular requirement exist for the PZB installation

5.7 Safety approval

The safety approval according to the valid European Standard EN 50 129 is not possible because the PZB system has been developed longtime before such standards have been placed. A retrospective safety approval according CENELEC standards is not possible because the necessary safety and quality documentation is not available and it would be very time consuming to prepare such documents. Development of safety functions have been based in the past on design rules and design principles as reflected in the German DB Standard MÜ8004, which is partly reflected in the CENELEC Standard EN 50 129. Considering that PZB is applied on more than 70 000 km track length and more than 8000 locomotives for many years and the native environment is similar or even identical to the intended application, the safety approval of the PZB system for HSL line for a limited period of time should not form any real obstacle. Of course, beside the technical aspects also juridical aspects must be considered. EN 50 129 and more specific the application guide to EN 50129 CLC/TR 50506-1 provides the ground for cross acceptance also for other systems than ERTMS. However, an assessment of the native application and their validity for the application on HSL Zuid is mandatory. It should be noted that PZB is not Fail-safe and does not comply with SIL 4 but it is considered by DB as sufficient safe for operation. The rules of “Grand fathers Rights” can be applied for the acceptance of the system. The acceptance for HSL Zuid is more a political and juridical issue rather than a technical safety issue.

5.8 Training

Training is required for the concerned train driver. Maintenance training could be performed by the DB Training Department

5.9 Testing

For testing of the installed Balises transportable test units are available. In addition, arrangement can be made with DB to use the PZB Test train for periodic tests.

5.10 Maintenance

The PZB is maintenance free the regularly works for cleaning, inspection and testing no maintenance of the wayside equipment is required

5.11 Future De-Commissioning for the transfer to ERTMS

No particular issue for the future transfer to ERTMS

5.12 Operational rules to be implemented

Any application outside the native environment should be avoided because cross acceptance and “Grand Father’s Rights” principles cannot refer to such applications. PZB cannot serve new functions outside the PZB application.

5.13 Potential risks (implementation, operation, development, approval, etc.)

No particular risk, however, a type installation is recommended by switching the Balises via mechanical contacts in order to ensure that any undiscovered effect produced by EMC or others could jeopardize the smooth implementation. Because the locomotives are already equipped by the PZB system, it should be very easy to perform such tests, which could also serve as initial testing of the safety behavior.

5.14 Rolling Stock

5.14.1 BR 186 and 189

All locos class 186 and 189 are equipped with PZB

5.14.1.1 Required modifications

No modifications.

5.14.1.2 Homologation

PZB is not implemented in PBA but in PBKA. If IVW and ProRail accept the PZB of PBKA via cross acceptance there is no need for more homologation. The probability for acceptance is high. The PZB is a usual system in Germany. The PZB equipment in the PBKA train sets is still homologated in Netherlands. Remark: Not the operation of PZB is homologated in the Netherlands, only the equipment.

5.14.1.3 Costs

No costs.

5.14.1.4 Potential risks

Low risks.

5.14.1.5 Recommendations

This is a good and cheap solution for current disposition.

5.14.2 Thalys

All Thalys in the version PBKA are equipped with the PZB. Only Thalys in the version PBA need supplementary equipment with PZB.

5.14.2.1 Required modifications

For the PBKA’s no modifications are needed, for the PBA’s is to fit in a PZB equipment. This equipment requires two PZB magnets on each end of the train set on the right side ahead, a PZB rack in the each of the two engine rooms, a connection to an existing wheel sensor on each train set head, a block of 3 lights in each driver’s desk and some cables to connect all these parts.

5.14.2.2 Homologation

The PBKA's are still homologated with PZB in Netherlands. The probability for acceptance of the PBA train sets with PZA is therefore also very high.

5.14.2.3 Costs

The cost for the device for one train set is round about 250 T€. The single costs are roundabout 250 T€ (change drawings, instructions for fit in, create checklist and so on). The results of the tests can be used for the homologation.

5.14.2.4 Potential risks

Low risks.

5.14.2.5 Recommendations

PBKA train sets can be used immediately with PZB without any costs.

Costs PZB Thalys PBA

T Euro	50	100	150	200	250
Thalys PBA	Development				
Thalys PBA *	Implementation				

* costs per trainset

Table 15 - PZB Costs Thalys PBA

Time PZB Thalys PBA

months	1	2	3	4
Thalys PBA	Development			Implementation

Table 16 - Time schedule PZB Thalys PBA

5.15 Time Schedule

The implementation of "No CC" as described in chapter 3 is required as a precondition for the installation of PZB. The necessary activities to install and commission "No CC" have been described. The schedule for installation and commissioning of PZB does consider that "No CC" will be established in parallel to PZB.

PZB + "No CC"	Year 1												Year 2							
	Start	Month											Month							
		1	2	3	4	5	6	7	8	9	10	11	12	1	2	3	4	5	6	7
Design Level 1 & 2																				
Design Level 3																				
Procurement																				
Installation																				
Testing & Commissioning																				
Safet Assessment																				
Safety Approval																				

Table 17 - Time schedule PZB Trackside Assembly

5.16 Costs (Track Side Assembly)

The PZB solution is not a self-standing solution. It requires the implementation of the “No CC” solution; therefore, in addition to the costs for PZB the “No CC” solution must be added

Description	Quantity	Cost/Unit (T€)	Cost (T€)
PZB Magnets & Interface unit*	13	6	78
Cables	1	10	10
Installation	13	2	26
Testing	1	30	30
Safety Approval	1	50	50
Sub-total 1			194
Design Engineering	16%		31
De-Commissioning	10%		8
Testing De-Commissioning	50% of initial Testing		15
Sub-Total 2			248
Contingencies PZB	10%		25
Total PZB		approximately	300
Total "No CC" solution			1.800
Grand Total PZB & "No CC"		approximately	2.100

Note * - Including PZB-magnets for tunnel protection

Table 18 - PZB Costs Trackside Assembly – NORTH & SOUTH

The costs do not include the costs for the train borne equipment. The 186, 189 and the Thalys PBKA train sets are already equipped with the PZB system. For the Thalys PBA an amount of approximately 250 T€ must be considered per train set..

5.17 Evaluation

Time Schedule for Implementation

The implementation the PZB solution is embedded in the time frame of the “No-CC Solution.

Safety

Homologation Train

The homologation of PZB is available except for the Thalys PBA train set, which should not form any risk.

Safety Acceptance Line

Application of cross acceptance and “Grand Fathers Rights” should not form any risk.

Auxiliary safety aspects

Tunnel protection made by additional protection signals can be supported by the PZB system. However, this application has not been used at Deutsche Bahn and needs a particular assessment.

Performances

Speed

It is proposed to limit the speeds to 160 km/h maximum

Headways

Same as for “No-CC” Solution

Operation

Same as for “No-CC” Solution

Costs

Costs for train sets

Trains are already equipped with the PZB system, except the Thalys PBA for which costs of 250 T€ will have to be considered per train set.

Costs for Line equipment

With approximately 2.3 Million €, the costs are reasonable.

Risks for Implementation

No significant risks beside the management of supplies and works.

Commissioning

No risk

De-Commissioning

No risk

No risk

De-Commissioning

No risk

6 Conclusion

The introduction of ERTMS in Europe bears risks in general and for each nation because not sufficient experience with public passenger transport does exist. Otherwise there are lines in operation with ETRMS. There are several examples where special tailored solutions have been applied (e.g. Spain, L1 with 300 km/h).

HSL Zuid also has faced several problems during the commissioning process and has chosen the solution to commission the line for a dedicated combination of train / infrastructure that has passed comprehensive tests, approvals and safety analysis. DBI encourages HSL Zuid to continue this concept and keep ERTMS as the intended Control Command Signal system for passenger transport.

DBI has established an overview (see appendix 7.8) of the alternative solutions and reflected upon various categories for assessment:

- Timeline for commissioning
- Safety
- Costs
- Performance
- Implementation Risks

Summarized the following can be stated:

- “No-CC-solution” allows operation under certain safety implications. The acceptability depends on the NSA and the operators. The realization is not complex and costs are reasonable. However, it cannot be interpreted as an alternative to ETCS and should only be taken into account as a temporary short-term solution.
- ATB-NG is complex for retrofitting the dedicated locos (BR 186, 189, Thalys), expensive and accompanied with unknown risks in fields of EMC and interferences of train parts. At least 2 years (determined by track-side assembly) are required to commission ATB-NG on HSL Zuid. Therefore DBI sticks to the conclusion of study Phase I to discard ATB-NG as a considerable alternative for ERTMS.
- Even though that PZB appears to be the best choice as an alternative solution, DBI does explicitly not recommend considering this as a realistic alternative for ETCS to start commercial operation with passenger transport. The current concept of HSL Zuid seems promising and would allow more flexibility for operation: VCO’s, tunnels, turnouts and emergency cross-overs, etc.
- ETCS L1 with 300 km/h would introduce further project risks if the system is intended for implementation during HSL Zuid in service (even under consideration of possessions during weekends and nights).

7 Appendix

7.1 Abbreviations

Abbreviation	Description
A	Austria
ADIF	Administrador de Infraestructuras. Ferroviarias (Railway Authority in Spain)
ATB	Automatische Treinbeïnvloeding (dutch atp system)
ATB-EG	ATB - FIRST GENERATION
ATB-NG	ATB - NEW GENERATION
ATC	Automatic Train Control
ATP	Automatic Train Protection
BE	Belgium
BR	Baureihe (Type of train)
CBI	Computer Based Interlocking
CEDEX	Centro de Estudios y Experimentación de Obras Públicas (Centre for studies and experiments for public works) - Spain
CC	Control Command
CCS	Control Command Signaling
D	Deutschland
DB	Deutsche Bahn
DB AG	Deutsche Bahn AG
DBI	DB International
DMI	Driver Machine Interface
ERA	European Railway Agency
ERTMS	European Rail Traffic Management System
ETCS	European Train Control System
EVC	European Vital Computer
HMI	Human machine Interface

Abbreviation	Description
HSA	High Speed Alliance
HSL	High Speed Line
HSLZ	HSL Zuid
HW	Hardware
IM	Infrastructure Manager
Integra	Swiss ATP system
IOP	Interoperability (Testing)
ISA	Independent Safety Assessor
IVW	Inspectie Verkeer en Waterstaat
KVB	Contrôle de vitesse par balises (French ATP system)
LZB	Linien Zug Beeinflussung (German ATP system for high speed)
Memor	Former ATP system from Luxembourg
MFOM	Ministerio de Fomento (Spanish ministry of transport)
MRCE	Misui Rail Capital Europ
NL	Netherlands
NoBo	Notified Body (for Interoperability)
NS	Nederlandse Spoorwegen (Dutch Railways)
NSA	National Safety Authority
OCC	Operational Control Centre
ÖBB	Österreichische Bundesbahnen (Austrian Railways)
OBU	On Board Unit
OPE	Operations
PBA	Thalys - Paris, Brussel, Amsterdam
PBKA	Thalys - Paris, Brussel, Köln, Amsterdam
PZB	Punktförmige Zugbeeinflussung (German ATP system)

Abbreviation	Description
RENFE	Red Nacional de los Ferrocarriles Españoles (National Railway Company of Spain)
RFI	Rete Ferroviaria Italiana (Italian Railway Network)
RCT	Real Configuration Tests
RST	Rolling Stock
SBB	Schweizer Bundes Bahn (Swiss Railways)
SEmSV	Sicherheitserprobung <u>mit</u> Sicherheitsverantwortung (Safety tests <u>with</u> ATP in safety responsibility)
SEoSV	Sicherheitserprobung <u>ohne</u> Sicherheitsverantwortung (Safety tests <u>without</u> ATP in safety responsibility)
SIL	Safety Integrity Level
SNCB	Société Nationale des Chemins de fer Belges (Belgian Railways)
SNCF	Société nationale des chemins de fer français (French Railways)
SRAC	Safety Related Application Conditions
SRS	System Requirement Specification
STM	Specific Transmission Module
SW	Software
SYS	System Integration
TBL1+	Transmission Balise-Locomotive (Belgian ATP system by eurobalises)
TBL2	Transmission Balise-Locomotive (New Belgian ATP system)
TC	Track Circuit
TEN	Trans European Network
TGH	Tunnel Groene Hart
TSI	Technical Specifications Interoperability
TVM	Transmission Voie-Machine (French ATP system for high speed)

Abbreviation	Description
UIC	Union Internationale Des Chemins De Fer (International Union of Railways)
VGB	Verklaring Geen Bezwaar (Declaration of innocuousness)
ZUB	Zugbeeinflussungssystem (Swiss ATP system)

7.2 Risk Assessment List - ETCS

#	Issue	Status, Responsible
1	<p>Does a complete documentation plan exist for system integration, including report on IOP tests (III), verification of system tests (XI), safety approval train type-track (V), integrated safety approval (I)?</p> <p><i>[for the references see best practice example SBB]</i></p> <p><i>[the documentation plan may be oriented on the structure given in EN 50126, chapter 6]</i></p>	
2	<p>Are all trackside, on-board and system integration related specifications, plans, safety cases, reports and certificates complete, released and up to date related to the finally installed HW/SW version?</p> <p>Has the configuration management continuously been applied?</p>	
3	<p>Are the ergonomic interfaces accepted by the users (RBC, operational center, on-board DMI) (including worker's council / trade unions if applicable)?</p>	
4	<p>Are all ISA / NoBo indications for issues to be checked on system level covered by system tests (e.g. axle counter compatibility, Eurobalise cross-compatibility, operational fallback situations, degraded situations)?</p>	
5	<p>Has the RBC-NRBC handover been tested and verified to sufficient extent, including technical and operational fallback scenarios?</p>	
6	<p>Are all safety relevant application conditions (SRAC) completely documented, their implementation proven and certified?</p> <p>Are all SRAC to trains grantable and their implications understood?</p> <p>Is at the system (track+train) level a defect and safety management in force, are all hazard log entries closed?</p>	
7	<p>Are all conditions and SRAC implemented in rules for driver, operator, maintenance staff?</p> <p>Has a certified training plan and schedule been implemented?</p>	
8	<p>Is the test specification complete (methods/tools used for deduction of tests from requirements and conditions, traceability)?</p> <p>Are fallback/failure situations included to a sufficient extent?</p> <p>Have the tests taken into consideration extreme parameter values?</p>	
9	<p>Are enough trains available for testing?</p>	

#	Issue	Status, Responsible
10	Are test results (including recorder traces), tools and qualified staff available for test evaluation?	
11	Are the test reports complete and valid (IOP and RCT)?	

7.3 Concept of Safety Approval (example SBB)

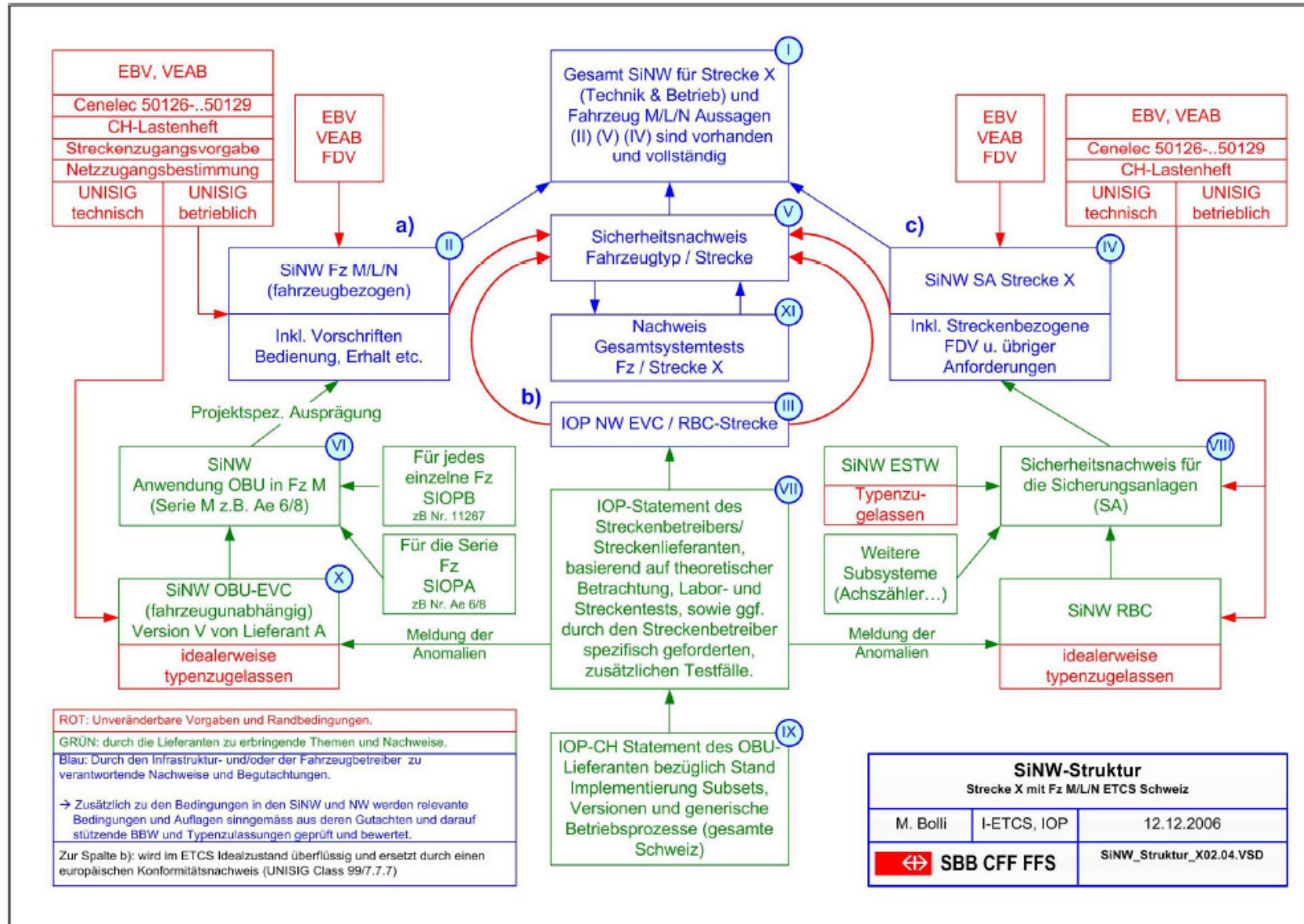

7.4 ATB-NG Layout

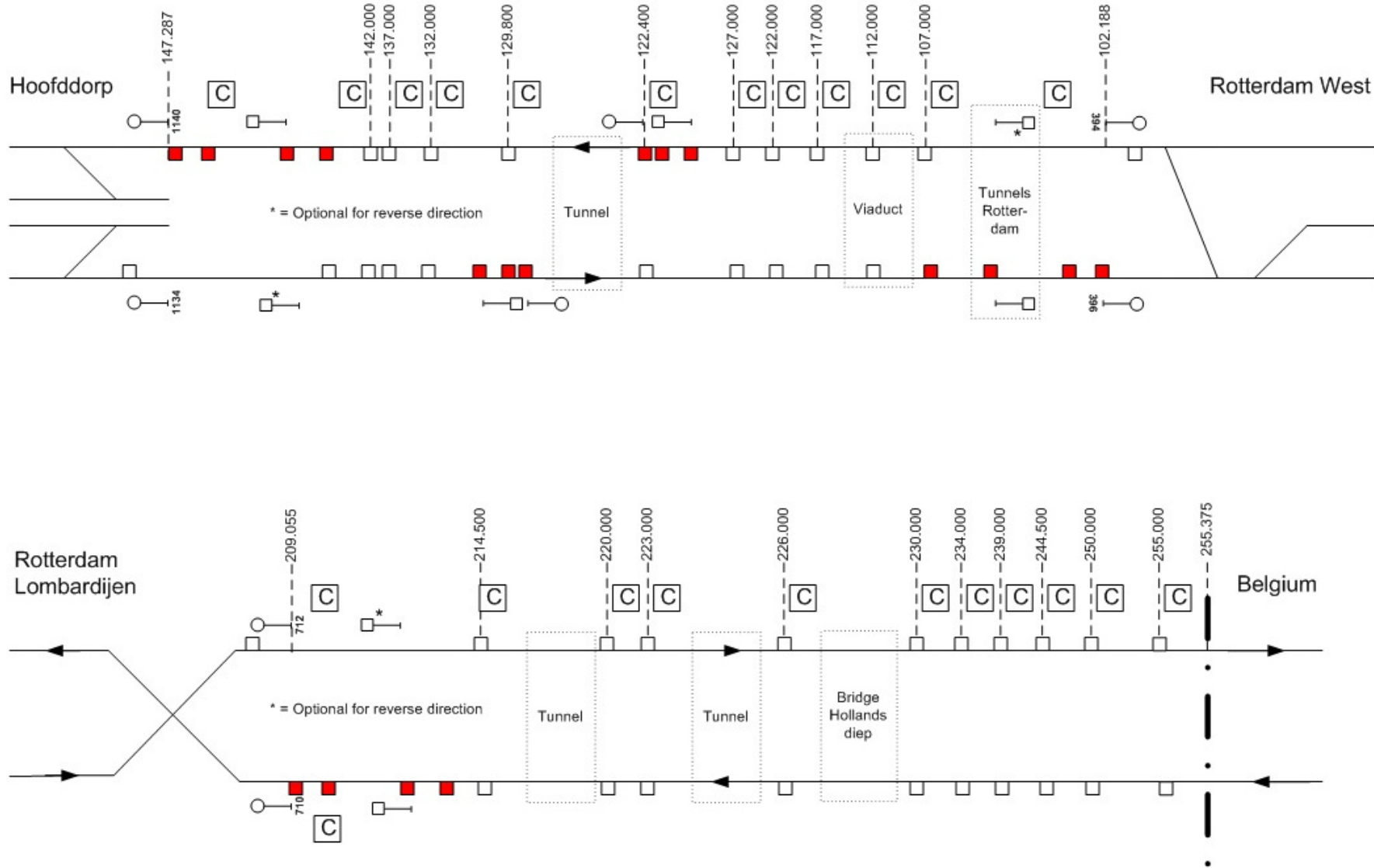

7.5 PZB Layout – Rotterdam West

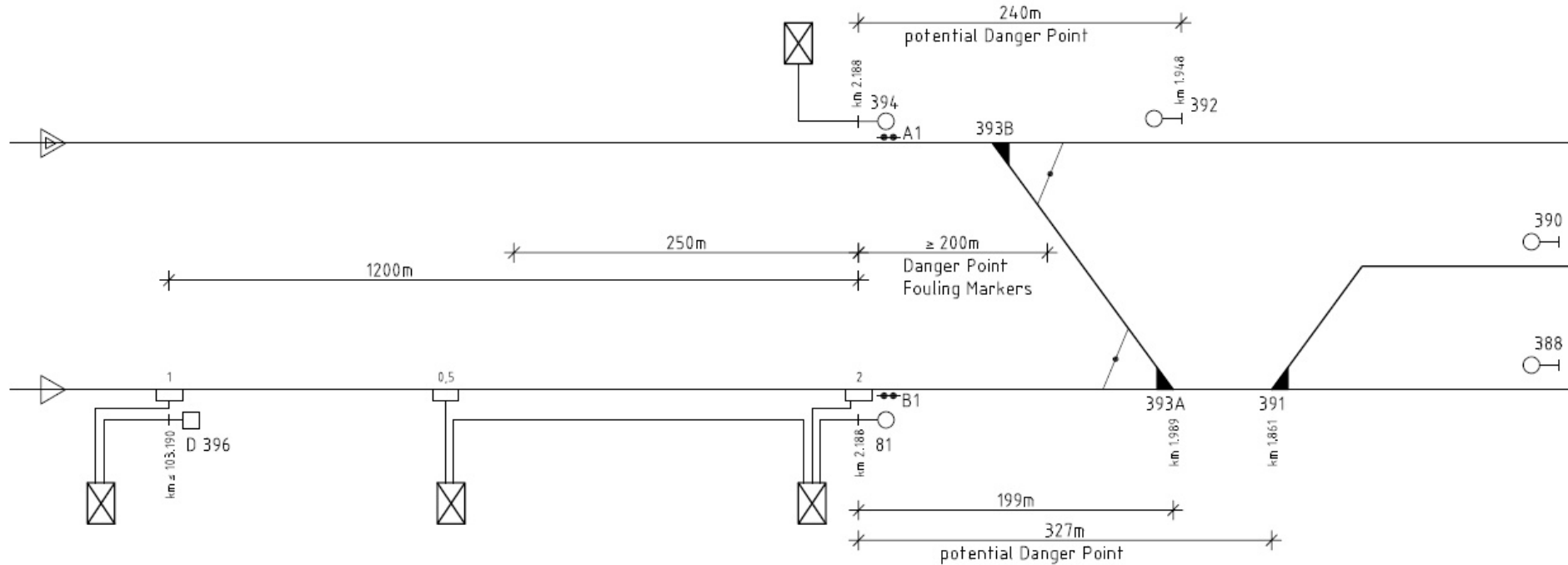

EHN1
km 107,632

Legend:

- Main Signal
- Distance Signal
- D ... Name of Distance Signal
- ▭— PZB - Magnet (switchable)
- ▭— PZB - Magnet (non-switchable)
- 0,5 / 1 / 2 Frequency of PZB - Magnet
- ⊗ Signal / PZB - cable box
- ◁ Normal Travel Direction of Traffic
- ▷ Reverse Travel Direction of Traffic

EHN1.1
(km 53,965)
(ProRail)

7.6 PZB Layout – Rotterdam Lombardijen

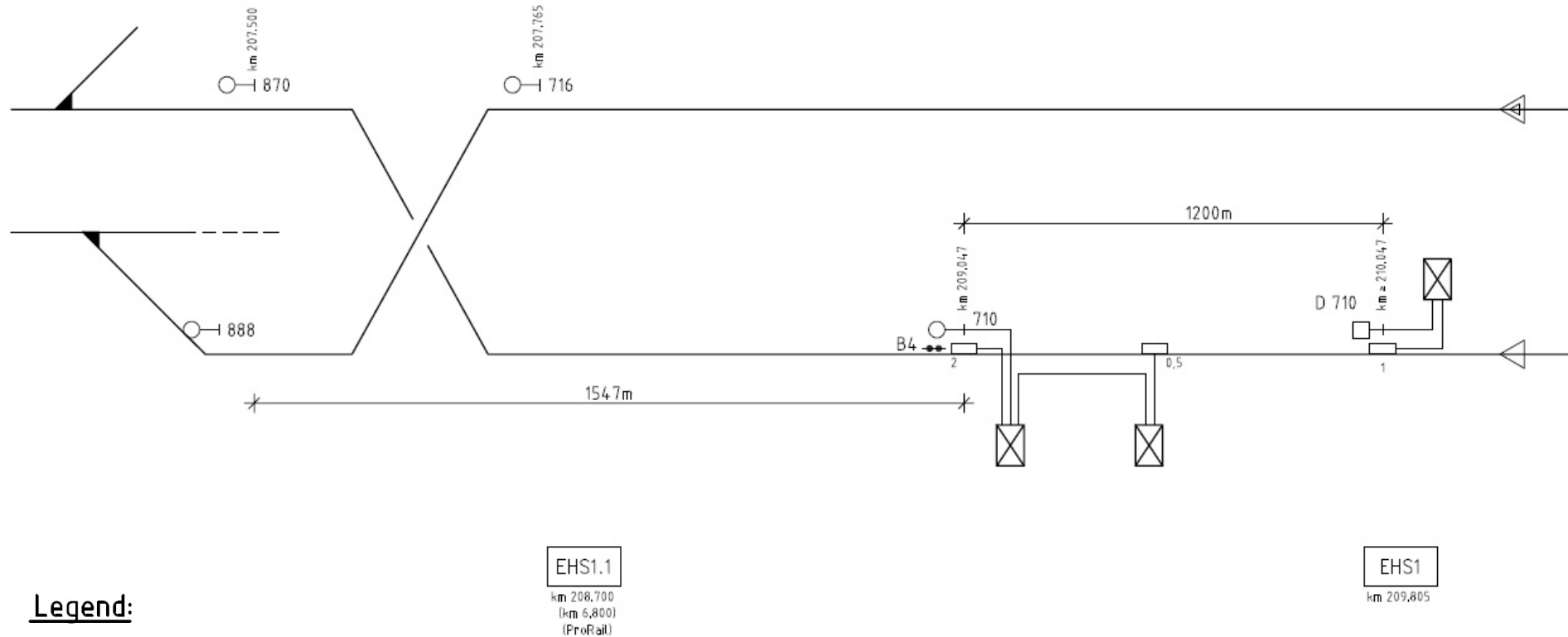

Legend:

- Main Signal
- Distance Signal
- D ... Name of Distance Signal
- ▭ PZB - Magnet (switchable)
- ▭ PZB - Magnet (non-switchable)
- 0.5/1/2 Frequency of PZB - Magnet
- ⊠ Signal/ PZB - cable box
- ◁ Normal Travel Direction of Traffic
- ▷ Reverse Travel Direction of Traffic

7.7 PZB Layout – Hoofddorp

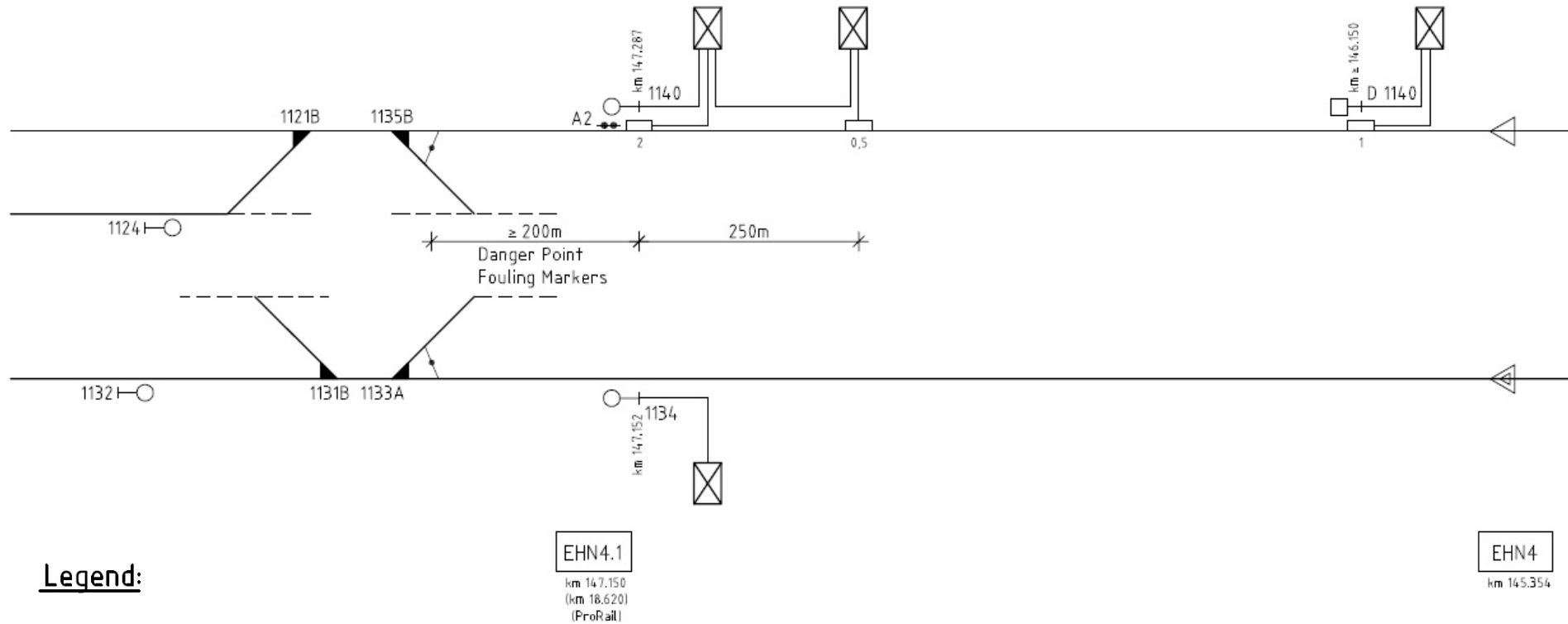

Legend:

- Main Signal
- Distance Signal
- D ... Name of Distance Signal
- PZB - Magnet (switchable)
- PZB - Magnet (non-switchable)
- 0.5 / 1 / 2 Frequency of PZB - Magnet
- ⊠ Signal / PZB - cable box
- ◁ Normal Travel Direction of Traffic
- ◁ Reverse Travel Direction of Traffic

7.8 Overview of alternatives

FINAL EVALUATION		Duration [months]	Safety			Costs		Performance		Implementation Risks	Comments
Applicable Solutions	Loc Type		Homologation Train	Safety Approval Line	Other safety Aspects	Costs Rolling Stock [T Euro]	Costs Line [T Euro]	Speed (Km/h)	Performance limitations for Operation		
No CC Solution	not applicable	13	not applicable (n/a)	safety assessment required, mitigation measures speed reduction, second driver	tunnel protection by special protection signals	not applicable	1.800	140	no access to branch lines, reverse signalling possible with very little benefit only	minor	The implementation of the signal solution "Without Control Command system" is required for the PZB solution and the ATB-NG solution as well. For a limited period and by applying mitigation measures such as speed restrictions and employing a second train driver, this solution should be acceptable.
	not applicable										
	not applicable										
PZB	189	13	available but no fail safe	cross acceptance / Grandfathers Rights to be applied	new application as tunnel protection in relation with signals,	0	2.100 (incl. No CC)	160	no access to branch lines, reverse signalling possible with very little benefit only	minor	The PZB solution can be considered as sufficient safe for operation for a limited period of time. The safety approval of the system should not form a real problem if the political will is there. The control of branch lines is not possible without major interlocking extensions, which are considered as not realistic. The additional costs to the no CC solution are minor. All trains except the Thalys PBA are already equipped and homologated. The risk of implementation is minor under the assumption that cross acceptance for PZB in the Netherlands is possible.
	186		available but no fail safe			0					
	Thalys		PBKA available, PBA to be done but no fail safe			PBA: 250 each trainset +1x 250 PBKA: 0					
ATB-NG	189	24	homologation to be done, time required 6 months	SIL 4 level safety approval available, operation with 25 KV to be assessed and certified	new application as tunnel protection in relation with signals,	450 each loco + 1x 1.000	North 5.000, South 4.600, No CC 1.800, = Total line 11.400	160	no access to branch lines, reverse signalling possible with very little benefit only	high	The ATB-NG system cannot be recommended as a temporary solution. The ATB-NG solution is relative costly and time consuming regarding the line side and the train borne implementation. The achieved safety level is high. It remains a minor risk of proper and safe working under 25 KV electrification.
	186		required for 25 KV, time required 4 months			PBA: 550 each trainset + 1x 1.000 DMI: 1x 700					
	Thalys										
ERTMS L1 V = 160 km/h	189	3	3 months for homologation	Safety Approval is in place	n/a	100	?	160	Full flexibility, VCO's, tunnels, turnouts and cross-overs	minor	The commissioning of ETCS L1 with BR 186 is the most promising solution.
	186	0	--			0					
	Thalys	9	9 months for homologation			700					
ERTMS L1 V = 300 km/h	189	?	Same as for L1 160 km/h	New safety analysis and Safety Case is required	Depending on Safety Analysis	Same as for L1 160 km/h	?	300	Full flexibility, VCO's, tunnels, turnouts and cross-overs Headway will be less than ETCS L2	considerable	A new system validation is required. An explicit design could indicate that additional balises are required. Considering that this solution will be implemented when the line is in operation for public passenger transport, the introduced risk is evaluated high.
	186										
	Thalys										