

Rapport 200

Elektrisch verdoven van pluimvee

Een evaluatie van de praktijk situatie in
Nederland.

Onderzoek naar elektrisch alternatieven.

Maart 2009

Colofon

Uitgever

Animal Sciences Group van Wageningen UR
Postbus 65, 8200 AB Lelystad
Telefoon 0320 - 238238
Fax 0320 - 238050
E-mail Info.veehouderij.ASG@wur.nl
Internet <http://www.asg.wur.nl>

Redactie

Communication Services

Aansprakelijkheid

Animal Sciences Group aanvaardt geen aansprakelijkheid voor eventuele schade voortvloeiend uit het gebruik van de resultaten van dit onderzoek of de toepassing van de adviezen.

Liability

Animal Sciences Group does not accept any liability for damages, if any, arising from the use of the results of this study or the application of the recommendations.

Losse nummers zijn te verkrijgen via de website.



De certificering volgens ISO 9001 door DNV onderstrept ons kwaliteitsniveau. Op al onze onderzoeksopdrachten zijn de Algemene Voorwaarden van de Animal Sciences Group van toepassing. Deze zijn gedeponeerd bij de Arrondissementsrechtbank Zwolle.

Abstract

Investigation of the current situation in Dutch slaughterhouses was performed in two rounds of visits. Physiological measurements were also performed on individual birds under controlled conditions. During these measurements the efficacy of the various parameter settings on consciousness was analyzed using EEG/ECG to determine brain and heart activity.

A similar series of physiological measurements were performed on broilers to determine the efficacy of alternative waveforms, an alternative location for electrode placement and an alternative method based on Transcranial Magnetic Stimulation.

Keywords

Stunning, waveform, frequency, current, electrode placement, transcranial magnetic stimulation.

Referaat

ISSN 1570 - 8616

Auteur(s)

V.A. Hindle
E. Lambooy
H.G.M. Reimert
L.D. Workel
M.A. Gerritzen

Titel

Electrical water bath stunning of poultry
Rapport 200

Samenvatting

Inventarisatie van de huidige situatie is in Nederlandse pluimveeslachterijen is uitgevoerd. De effectiviteit van de in de praktijk toegepaste instellingen (Voltage en frequentie) zijn op individueel dierniveau getoetst. Effectiviteit van de toegepaste parameters of bewusteloosheid, duur van bewusteloosheid en hartstilstand is beoordeeld op basis hersenactiviteit (eeg), hartactiviteit (ecg) en reacties op pijnprikkels.

Vergelijkbare metingen zijn verricht bij vleeskuikens die zijn blootgesteld aan alternatieve elektrische golfvormen, alternatieve toedieningsroutes (kop-cloaca) van elektrische stroom en aan een alternatieve methode voor het opwekken van een elektrisch veld in de hersenen (TMS).

Trefwoorden

Verdoven, golfvormen, frequentie, stroomsterkte, plaatsing elektroden, TMS.



Rapport 200

Electrical water bath stunning of poultry

Electrical water bath stunning of poultry.

An evaluation of the present situation in Dutch slaughterhouses and alternative electrical stunning methods.

V.A. Hindle
E. Lambooij
H.G.M. Reimert
L.D. Workel
M.A. Gerritzen

March 2009

Dit onderzoek is uitgevoerd binnen het beleidsondersteunend onderzoek in het kader van LNV-programma Dierenwelzijn projectnummer: BO-07-011-038.

Voorwoord

In de samenleving en in de Europese politiek is er veel discussie over het verdoven en doden van dieren. Het elektrisch verdoven van pluimvee is een belangrijk onderdeel van deze discussie.

De Animal Sciences Group is gevraagd om inzichtelijk te maken hoe en met welke instellingen elektrische verdoving van pluimvee in Nederland wordt toegepast. Daarnaast is gevraagd duidelijkheid te krijgen over de verwachte effectiviteit van de toegepaste methoden en of er alternatieve vormen van elektrisch verdoven mogelijk zijn.

In dit rapport treft u een overzicht van de huidige toepassing van de elektrische waterbad verdoover bij pluimvee. Verder zijn onderzoeksresultaten over de effectiviteit van de instellingen, van alternatieve stroomvormen en alternatieve toedieningsmethoden (TMS) en toedieningsroutes (kop-cloaca) in dit rapport weergegeven. Om te komen tot een betrouwbare in-line meetmethode is een concept meetrobot ontwikkeld. Op basis van de conclusies volgend uit de verschillende experimenten in dit project worden aanbevelingen gedaan om te komen tot een verbetering van het dierenwelzijn tijdens elektrisch verdoven.

Dr. ing. M.A. (Marien) Gerritzen.

This research was performed for the Dutch Ministry for Agriculture, Nature management and Food safety within the framework of animal welfare policy support. Project number: BO-07-011-038.

Preface

Stunning and slaughter of animals are presently topics of discussion within society and European politics. Electrical stunning of poultry is an important aspect within this discussion.

The Animal Sciences Group has been asked to provide an insight into the present practice and technical settings used for stunning poultry in the Netherlands. In addition, it has been requested that this report provide more clarity regarding the expected efficacy of alternatives for waveforms, route of stun application (head to cloaca), stunning method (TMS) and measuring device (robot). Several recommendations are proposed, based on the conclusions from the various aspects investigated within this study, with an aim to improve animal welfare during electrical stunning.

Dr. ing. M.A. (Marien) Gerritzen.

Samenvatting

In wetgeving is vastgelegd dat slachtdieren voorafgaand aan het doden door verbloeden op een adequate manier moeten worden bedwemeld. Met een adequate bedwelmeling wordt bedoeld een staat van bewusteloosheid en ongevoeligheid die aanhoudt tot de dood intreedt door verbloeden.

De meest toegepaste methode voor het verdoven van pluimvee is in een elektrisch waterbad. Bij binnenkomst in de slachterij wordt het dier uit de transportkrat gehaald en met de poten in de slachthaak aan de slachtlijn gehangen. De dieren worden vervolgens door een waterbad gevoerd. Op het waterbad staat een constante spanning (Volt) waarbij het water de positieve elektrode is en de slachthaak de negatieve elektrode. Door contact te maken met het water gaat er een elektrische stroom door de dieren lopen. De stroomsterkte (ampère) die hierdoor door de dieren loopt moet voldoende zijn om de hersenactiviteit zodanig te verstoren dat het dier onmiddellijk het bewustzijn verliest. De minimum stroomsterkte die een individueel dier in een waterbad moet krijgen is wettelijk vastgesteld op 100 mA. Voor het garanderen van een effectieve bedwelmeling in een elektrisch waterbad spelen meerdere aspecten een belangrijke rol. Aspecten die een bijdrage leveren aan de effectiviteit van de bedwelmeling zijn het aantal dieren dat tegelijk in het waterbad zit, de verdovingsduur, golfvorm, frequentie, stroomsterkte en individuele weerstand van dieren. In deze studie is geïnventariseerd hoe deze aspecten in Nederlandse vleeskuiken-, hennen- en eendenslachterijen variëren. Daarnaast zijn de effecten van deze verschillende aspecten op dierniveau onderzocht. Bovendien zijn de effecten van alternatieve golfvormen, alternatieve plaatsing van elektrodes en alternatieve toedieningswijzen onderzocht en is een apparaat ontwikkeld dat aan de slachtlijn de elektrische parameters kan registreren.

Methode

Inventarisatie van de huidige situatie in Nederlandse pluimveeslachterijen is uitgevoerd door middel van twee bezoek rondes. Tijdens de eerste ronde zijn er 10 verschillende slachterijen bezocht waar vleeskuikens, leghennen of eenden werden geslacht. Tijdens de eerste ronde is geïnventariseerd welke verdovingsinstellingen zijn toegepast.

Tijdens de tweede ronde zijn bij 8 van deze slachterijen de elektrische parameters met behulp van een in-line meetinstrument, ontwikkeld binnen dit onderzoek, vastgelegd.

De effectiviteit van de in de praktijk toegepaste instellingen (Voltage en frequentie) zijn op individueel dierniveau getoetst. Effectiviteit van de toegepaste parameters op bewusteloosheid, duur van bewusteloosheid en hartstilstand is beoordeeld op basis van hersenactiviteit (EEG), hartactiviteit (ECG) en reactie op pijnprikkels. Vergelijkbare metingen zijn verricht bij vleeskuikens die zijn blootgesteld aan alternatieve elektrische golfvormen, een alternatieve toedieningsroute (kop-cloaca) van elektrische stroom en aan een alternatieve methode voor het opwekken van een elektrisch veld in de hersenen (Transcraniale Magnetische Stimulatie, TMS).

Resultaten

Stand van zaken in slachterijen:

Tijdens de eerste ronde van bezoeken aan 10 Nederlandse slachterijen is vastgesteld dat er een grote variatie is in het aantal dieren in het elektrisch waterbad (4-27), in verdovingsduur (4-16 seconden) en in ingesteld voltage (35-250 V) en frequentie (50 – 2000Hz). De stroomsterkte gemeten in de haak of vlakbij het waterbad varieerde van 20-133 mA. Bij benadering werd een variatie van 650-2170 ohm in elektrische weerstand berekend.

Metingen aan het elektrisch waterbad door middel van een commerciële stroommeter bleek maar in een beperkt aantal situaties mogelijk. Grootste belemmering hierin was de benaderbaarheid van het waterbad. Tijdens de tweede ronde bezoeken werden de spanning (voltage), de frequentie en de geleverde stroomsterkte gemeten door een meetinstrument aan de slachthaken en in het waterbad te laten hangen. De gemeten spanning (60-202 V), de frequentie (50-2000 Hz) en de stroomsterkte (24-216 mA) varieerde sterk. Hierbij werd de meetinstrument steeds op weerstanden tussen 1000 en 2500 ohm ingesteld.

Individuele metingen:

Op basis van de aan individuele dieren gemeten EEG's, ECG's en reacties op pijnprikkels kan worden geconcludeerd dat er een groot verschil is in elektrische weerstand tussen dieren en tussen koppels. Dit resulteerde in een grote variatie in toegediende stroomsterkte. Tevens is er een groot diereffect op de kans dat een toegepaste verdoving effectief is. Er is geen significant verschil in effectiviteit van de verdoving tussen vleeskuikens, hennen en eenden.

Het is duidelijk dat bij hogere frequenties een beduidend hogere stroomsterkte nodig is om te komen tot een effectieve bedwelmeling. Bij deze hogere frequenties en hogere stroomsterktes blijken er net als bij lage frequenties ook spierbloedingen te ontstaan.

Alternatieve golfvormen voor een effectieve bedwelmings:

In een pilot onderzoek zijn negen verschillende elektrische golfvormen als alternatief voor de standaard sinus golfvorm onderzocht. Alle negen golfvormen waren blokvormige wisselspanningen met een verschillende "duty cycle" (effectieve periode) en verschillende conformaties. Van deze golfvormen bleken zeven vormen bij gebruik van een stroomstoot van 0,5 seconde of vijf seconden geen of onvoldoende bewusteloosheid te induceren. Twee van deze alternatieve, blokvormige wisselspanning zijn verder onderzocht.

Toepassing van een golfvorm met een duty cycle (effectieve periode) van 43% ("Craft 43%") leidde bij 15 (68% van de dieren bedwemd voor 5s) dieren tot een effectieve bedwelmings. Deze bedwelmings werd gerealiseerd bij een sterk variërende stroomsterkte van 139 ± 135 mA. Het geïnduceerde bewusteloosheid duurde gemiddeld 42 seconden.

Toepassing van een golfvorm met een duty cycle (effectieve periode) van 32% ("Wave 32") leidde in 8 gevallen (72% van de dieren bedwemd voor 5s), bij een effectieve stroomsterkte van 237 ± 206 mA, tot een effectieve bedwelmings. De bewusteloosheid duurde gemiddeld 27 seconden.

Alternatieve toedieningsroute (kop-cloaca) voor een effectieve bedwelmings:

Toediening van elektrische stroom via een alternatieve route waarbij de stroom niet door de looppoten gaat wordt gezien als een belangrijke mogelijkheid om de stroomsterkte die nodig is voor een effectieve bedwelmings te verminderen.

Toedienen van een blokvormige wisselstroom (100% duty cycle; 600 Hz) gedurende 0,5 seconden leidde tot een effectieve verdoving bij een stroomsterkte van 105 ± 7 mA.

Het toedienen van alternatieve golfvormen via de kop-cloaca route leidde niet tot een verlaging van de stroomsterkte nodig voor een effectieve bedwelmings.

Alternatieve toedieningsmethode (TMS):

Na het magnetisch stimuleren (TMS) van de hersenen treedt een acute verandering op in het EEG, die er op duidt dat de vleeskuikens ongeveer 20 s diep in narcose zijn en daarna een verminderd bewustzijn hebben en min of meer bijkomen. Hoe lang het dier in totaal bewusteloos blijft is niet helemaal duidelijk. De methode moet nog verder worden uitontwikkeld.

Algemene conclusies

Er zijn grote verschillen tussen de Nederlandse slachterijen (vleeskuikens, leghennen en eenden) in toepassing van elektrische waterbad verdoovers. Deze verschillen betreffen het aantal dieren dat tegelijk in het waterbad gaat, de verdovingsduur, de toegepaste spanning (V), de stroomsterkte (mA) en frequentie (Hz).

Op basis van de gemeten praktijk instellingen (V, Hz), de verschillen in elektrische weerstand tussen dieren en het verschil in gevoeligheid tussen dieren onderling is het zeer aannemelijk dat onder de huidige praktijk omstandigheden een aanzienlijk deel van de dieren niet voldoende wordt bedwemd in het elektrische waterbad.

Er zijn grote verschillen gemeten in gerealiseerde stroomsterkte (mA) per individueel dier. Bij gelijk (ingesteld) spanningsverschil duidt dit op grote verschillen in elektrische weerstand tussen dieren zowel binnen een koppel als tussen koppels.

Onder de huidige praktijkomstandigheden kan niet voor elk individueel dier worden vastgesteld welke stroomsterkte is gerealiseerd.

Voor een adequate en objectieve beoordeling van elektrische verdoovers in slachterijen is een in-line meetmodule noodzakelijk. Deze meetmodule registreert voltage, stroomsterkte en frequentie. De in dit onderzoek ontwikkelde concept meetmodule is hiervoor een bruikbare methode maar verdere aanpassing voor praktijktoepassing op grotere schaal is nodig.

Bij een toegepaste frequentie van 50Hz wordt voor de meeste dieren een effectieve verdoving bereikt bij 100mA bij een stroomstoot van 5s. Bij het toepassen van hogere frequenties zijn hogere stroomsterktes nodig om een effectieve bedwelmings te realiseren. De huidige wetgeving (100mA ongeacht frequentie) voldoet daarom niet en zou ook rekening moeten houden met de toegepaste frequentie en golfvormen.

Effectieve elektrische bedwelmings is sterk positief gecorreleerd met het optreden van spierbloedingen, ook bij hogere frequenties. Het is duidelijk dat alternatieve golfvormen met een verschillende 'duty cycle' (effectieve

periode) een effectieve verdoving kunnen induceren. Kortere 'duty cycles' vereisen echter hogere effectieve stroomsterktes om te komen tot effectieve verdoving. De hogere stroomsterktes leiden ook hier tot spierbloedingen. Het toepassen van alternatieve golfvormen bij de elektrische waterbad verdoving geeft dan ook geen verbetering ten opzichte van de huidige standaard golfvorm.

Het toepassen van een alternatieve stroomroute zoals kop-cloaca in plaats van de conventionele stroomroute door de voeten en poten geeft een aanzienlijke reductie in benodigde stroomsterkte om te komen tot een effectieve verdoving.

Transcraniale Magnetische Stimulatie (TMS) is in potentie een alternatief voor de conventionele stroombronnen. Een verdere ontwikkeling van de methode is noodzakelijk om in de praktijk toegepast te kunnen worden.

Aanbevelingen

De huidige wettelijk norm voor het elektrisch verdoven moet worden aangepast waarbij rekening gehouden moet worden met de stroomfrequentie en 'duty cycle' (effectieve periode).

Monitoren van de toegepaste instelling in de praktijk moet aan de slachtlijn op dierniveau plaats vinden. Het praktijkrijp maken van de hier ontwikkelde en gebruikte meetmodule is hiervoor noodzakelijk.

Het gebruik van het elektrische waterbad in de huidige vorm en toepassing dient ontmoedigd te worden omdat niet gegarandeerd kan worden dat alle dieren voldoende stroom toegediend krijgen.

De volgende aspecten, die van belang zijn voor het correct bedwelmen van pluimvee, dienen verder te worden ontwikkeld voor toepassing in de praktijk:

- Ontwikkelen van alternatieve stroomroutes;
- Individuele toediening van elektrische stroom;
- Ontwikkelen van alternatieve stimulatie methoden van de hersenen (opwekken bewusteloosheid);
- Ontwikkelen van een betere manier van fixatie van het dier tijdens het bedwelmen.

Summary

Current legislation demands that all birds are immediately rendered unconscious at stunning and that they remain insensible until death ensues. Use of the water bath is a legal electrical stunning method for poultry. In order for a stun to conform with the demands of legislature several aspects of the water bath method are of importance to its successful execution. The legal minimal current for an individual bird in the water bath is 100 mA. Aspects that can greatly influence the affectivity of the stun include quality of contact between bird and electrodes, numbers of birds simultaneously present in the water bath, duration of stun, amount of current entering the bird (measured in amperes), waveform, frequency (Hz) of application and voltage (V) applied. These aspects were topics of investigation during this study of the present situation of electrical water bath stunning of poultry in broiler, hen and duck slaughterhouses in the Netherlands. Furthermore, alternative wave forms, alternative electrode placements, an alternative route of electricity supply were investigated as potential options and an in-line measuring apparatus was developed.

Method

Investigation of the current situation in Dutch slaughterhouses was performed in two rounds of visits. During the First round 10 slaughterhouses were visited. These included establishments specialized in the slaughter of broilers, hens or ducks. The parameter settings for electrical stunning were measured and recorded.

During the second round 8 of these slaughterhouses were revisited. This time a prototype of a (stand alone) in-line measuring device (developed in this study) was used for measurement of the technical parameters (current, voltage, frequency and impedance). The measuring device was hung in the shackles instead of a bird and ran through the water bath for each measurement.

Physiological measurements were also performed on individual birds under laboratory conditions. During these measurements the efficacy of the various parameter settings on consciousness was analyzed using EEG/ECG to determine brain and heart activity.

A similar series of physiological measurements were performed on broilers to determine the efficacy of alternative waveforms, an alternative location for electrode placement and an alternative method based on Transcranial Magnetic Stimulation (TMS).

Results

Current situation in slaughterhouses:

Measurement during the first round was performed with a hand-held voltmeter and was difficult to perform without risk to personal safety. However, large variation was found in the numbers of birds in the water bath (4-27) simultaneously. On average the birds remained in the bath for 4-16 seconds which also indicates the variation in stunning time. Frequency of the applied current varied considerably (50 – 2000Hz) as did voltage (935 – 250 V) and electrical impedance (650-2170 ohm) of the birds. This resulted in a large variation in the level of current measured at the water bath (20-133 mA) although measurement was only possible in 6 of the 10 slaughterhouses.

Round two resulted in similar levels of variation. The number of birds in the water bath (15-27) and average stay (stun duration) in the bath (11-33 sec) showed considerable variation between slaughterhouses. Measurement of current, frequency (50-2000Hz) and voltage (60-202 V) was performed at varying impedance (920-2630 ohm) settings using a prototype in-line measuring device. The levels of current measured yet again displayed considerable variation (24 -216 mA). Although this time measurements were performed in the shackles and in all 8 slaughterhouses.

The physiological measurements on individual birds in our laboratory showed that:

- Current required to facilitate a successful stun differs significantly between broilers, hens and ducks.
- Higher frequencies require higher currents to facilitate an adequate stun.
- Results vary considerably between individual birds, groups and measurement dates.
- Type of bird (broiler, hen or duck) and bodyweight do not have a significant effect on probability of a successful stun.

Alternative waveform values for an effective stun:

In an initial pilot 9 waveforms were tested as alternatives to a standard sinus. These were all square waveforms varying in duty cycle (dc). Most (7) of the experimental wave designs were unsuccessful in delivering an acceptable stun (duration 0,5 en 5 s at 600Hz) due to low currents (55 -140 mA). Two designs, both square AC waves with either 43% or 32% dc, were chosen for further study. These waves were used in individual stuns on broilers. The square wave with a 43% dc resulted in 15 (68%) successful 5 second stuns with voltage input at

151 ± 223 V, requiring on average 139 ± 138 mA current. The impedance calculated as 1,6 ± 0,9 Ω. On average, use of the waveform with 43% dc resulted in unconsciousness lasting for 42±20 seconds. The 8 (72%) successful 5 second stuns completed with the square wave with 32% dc required on average an input of 424 ± 211V which delivered on average 237 ± 206 mA implying an impedance of 0.5 ± 0.4Ω. Here the period of unconsciousness was shorter (26±6 seconds) than with the 43% dc.

Alternative waveforms can be correctly administered to effectively stun broilers. Unfortunately, they require higher voltages and currents which do not provide the anticipated reduction in the incidence of blood splashing.

Alternative positioning of electrode (head-to-cloaca):

Placement of the electrode on or in close proximity to the cloaca was also investigated in an attempt to divert the path of the current entering the bird. This to reduce the impedance by passing the feet and legs. Measurements were first performed using a square wave 100% dc and later on broilers receiving current applied using the alternatives with 43% or 32% dc. Using the square wave 100% dc for 0.5 second stuns required an input of 101 ± 18 V, supplying 105 ± 7mA with impedance calculated at 1.2 ± 0.4 Ω. Most birds (12 out of 15) recovered within 5 minutes. Several (n=11) stuns (0.5 or 3 s) were performed with the square wave 32% dc and 43% dc with varying success. These required on average an input of 65± 8 V, supplying 94 ± 0.7 mA. Impedance was calculated at 0.5 ± 0.1 Ω. Only one of the stuns was successful and the bird recovered consciousness within 1 minute.

Alternative positioning of the electrode (head to cloaca) provides a good alternative due to the reduction in requirements for voltage and currents, consequently reducing the incidence of blood splashing.

TMS:

After magnetic stimulation (TMS) of the brain an acute change in the EEG pattern was observed which indicates that broilers are in a state of unconsciousness for approximately 20 seconds after which they displayed drowsiness and recovered. However, it remains unclear how long they remain unconscious.

Conclusions

Large differences were observed between slaughterhouses in the settings for water bath stunning parameters for broilers, hens and ducks. These differences were seen with regard to the varying numbers of birds present in the water bath, variation in stunning duration, voltage (V) and frequency (Hz) levels applied.

Based on the observed differences in technical settings (V, Hz), and between-animal differences in impedance and between-animal differences in sensitivity, it is highly probable that large numbers of birds are inadequately stunned during current usage of the water bath technique in slaughterhouses.

Large differences were measured in the strength of current (mA) applied to each bird. At the same voltage settings this implies large differences in electrical impedance between individual birds within and between groups.

Under present conditions in practice it is impossible to measure exactly the level of current (mA) each bird receives during water bath stunning.

In-line measurement is an essential aid in order to provide an adequate and objective evaluation of current water bath stunning in Dutch slaughterhouses. The prototype device developed in this study measured voltage (V), current (mA) and frequency (Hz). The prototype measuring device has shown its potential but should be developed further before it can be accepted for practical application.

Use of a wave frequency of 50Hz applied for 5s and delivering a current of 100 mA produces an effective stun in most birds. Applications using higher frequencies require higher levels of current (mA) to produce effective stuns. Present legislation (100 mA irrespective wave frequency) is inaccurate because it does not account for frequency and other wave characteristics (i.e. amplitude, duty cycle and waveform).

Effective electrical stunning causes blood splashing in muscle tissue, also at higher frequencies.

Alternative waveforms with differing duty cycles (active period) are capable of inducing an effective stun with broilers. However, shorter duty cycles require higher levels of current to produce an effective stun. These higher currents also result in blood spots. Alternative waveforms do not lead to more effective stunning. Therefore, application of alternative waveforms for water bath stunning do not provide an improvement as compared to conventional waveforms.

Alternative positioning of the electrode onto the cloacal region of the bird, instead of the conventional method via the feet and legs, reduces the current level required at a higher frequency for an effective stun. Transcranial magnetic stimulation (TMS) is a potential alternative for use as stunning method for broilers that should be developed further.

Recommendations

Present legal standards for electrical stunning of poultry must be adapted to include specification of frequency and duty cycle.

Measurement of the application settings in practice must be performed in line at animal level. Further development of the prototype in line measuring device is essential to monitor application settings under practical conditions.

Use of the conventional electrical water bath in its present form is to be strongly discouraged because of the inability to guarantee that each bird receives sufficient current for an effective stun.

The following important aspects should be developed further for practical application:

- Alternative pathways for application of stunning;
- Individual application of an electrical stun;
- Alternative electrical stunning methods;
- Improved methods of restraining birds during stunning.

Inhoudsopgave

Voorwoord

Perface

Samenvatting

Summary

1	Introduction	1
1.1	Aim of the project.....	1
1.2	Background information.....	2
2	Present situation of electrical stunning of poultry in the Netherlands.....	3
2.1	Introduction	3
2.2	Materials and methods.....	3
2.2.1	First round of visits.....	3
2.2.2	Second round using in line measuring device.....	3
2.3	Results.....	3
2.3.1	First round.....	3
2.3.2	Second round with in line measuring device.....	4
2.4	Conclusions.....	4
3	Controlled laboratory measurements with individual birds	5
3.1	Introduction	5
3.2	Materials and methods.....	5
3.2.1	Animals.....	5
3.2.2	Experimental design.....	5
3.2.3	Brain and heart activity	5
3.2.4	Statistical analysis.....	6
3.3	Results.....	8
3.3.1	Broilers.....	9
3.3.2	Hens.....	15
3.3.3	Ducks	18
3.3.4	Statistical analysis.....	20
3.4	Conclusions	22
4	Alternative waveforms	23
4.1	Introduction	23
4.2	Materials and methods.....	23
4.2.1	Experimental animals.....	23
4.2.2	Laboratory trials under controlled conditions.....	24
4.2.3	Waveforms	24
4.3	Results.....	26
4.4	Conclusions.....	28

5	Alternative routing of current application (head-to-cloaca).....	29
5.1	Introduction	29
5.2	Materials and methods.....	29
5.2.1	Animals.....	29
5.2.2	Procedure	29
5.2.3	Waveforms	29
5.2.4	Statistical analyses.....	29
5.3	Results	30
5.4	Conclusions.....	32
6	An alternative to electrical stunning: Transcranial Magnetic Stimulation (TMS).	33
6.1	Introduction	33
6.2	Materials and method	33
6.2.1	Experimental animals.....	33
6.2.2	Experimental procedure.....	33
6.2.3	Stimulator settings.....	34
6.2.4	Analysis of EEG signals.....	35
6.3	Results	35
6.4	Conclusions.....	38
7	The development of a stand alone in line measuring device.....	39
7.1	Introduction.....	39
7.2	Design.....	39
7.3	Technical aspects.....	39
7.4	Results.....	41
7.5	Conclusions.....	42
8	Conclusions	43
	Conclusies	44
9	Recommendations	45
	Aanbevelingen	46
	Literature	47

1 Introduction

Current European (EU Council Directive, 1993) and Dutch legislation (NL, GWvD 1992; besluit doden van dieren 1997) demands that animals are adequately stunned rendering them immediately insensible to the killing process until dead. Whichever stunning method is employed it is important that the stun leads to immediate loss of consciousness and that the animal remains insensible to pain, fear, stress and excessive distress. Stunning should immobilize the animal to such an extent as to facilitate a swift and accurate bleeding out via a neck cut. A correctly performed neck cut will ensure that the animal does not recover consciousness and therefore limit the risk of unnecessary distress during bleeding. Additionally, it is essential that the stunning method does not have a detrimental affect on carcass and product quality (Blackmore & Delany, 1988).

It is generally accepted that for poultry unconsciousness should occur immediately (within 1 second) after an electrical stun and that the animal should remain in a state of unconsciousness for the sum of time that lapses between the end of the stun and the time taken to bleed out and die. A minimum of 40 or 52 seconds, depending on the combination of stun duration and current levels, have been considered as sufficient periods of unconsciousness for poultry (Gregory and Wotton, 1990, Raj, 2006).

Electrical stunning and Controlled Atmospheric Stunning (CAS) are the two major methods used in commercial slaughterhouses throughout Europe (Fernandez, 2004). Electrical stunning of poultry in a water bath has long been the common method in Europe and the Netherlands. The water bath method is based on application of a current flow through the body of the bird which is hung head-down by the legs in moving shackles. Thereafter, the birds pass through the bath in line. Depending on the dimensions of the bath several birds are submerged (up to their shoulders) simultaneously in water. Conventionally, a metal strip in the base of the water bath forms one electrode while the shackles are earthed and form the negative electrode, so that the electric current passes through the bird in the direction from head to legs. The water bath is electrically live so that each bird is stunned from the moment it makes contact with water (Bilgili, 1999, Fernandez, 2004).

Under practical conditions the presence of several birds at the same time in the water bath creates a parallel pathway of resistance. It has been claimed that under slaughterhouse conditions only about one third of birds are effectively stunned, while one third are inadequately stunned and the remaining third undergo cardiac arrest (Woolley et al., 1986). The shackles and framework together with the bird itself form a conductive resistance to the current thus are potential sources of loss of electrical capacity. These sources of resistance are variable due to bird resistivity (skull bone structure and thickness (Woolley et al, 1986a,b)), and shackle condition (degree of fouling, contact area with bird). These variations in resistance can influence the quality of the stun so that some birds receive too much while others receive insufficient current. Ultimately, this can lead to problems with either bird welfare (failure to lose consciousness or rapid recovery) or product quality (haemorrhaging, bone fractures).

1.1 Aim of the project

An inventory of the present situation in Dutch slaughterhouses was envisaged in order to assess the state of slaughter procedures in relation to the requirements based on current recommendations (EFSA, 2004, 2006) and legislation (NL, GWvD 1992; besluit doden van dieren 1997, EU directive, 1993, EC council, 2005). The main aim of the inventory was the measurement of relevant parameter settings such as voltage, amperages and frequencies at water bath level (section 2).

Measurements on individual birds were envisaged to determine the efficacy of the recommended application levels and those observed during the investigation of current practice in Dutch slaughterhouses. The individual measurements were conducted to determine the effects of the technical settings on consciousness in broilers, hens and ducks and carcass quality (blood splashing) in broilers (section 3).

Alternatives to the standard AC sine waveform have been considered in the past (Gregory and Wotton, 1987, Ingling and Kuenzel, 1978, Bilgili, 1992, Wilkins et al., 1998, Raj, 2006) without appropriate knowledge of the affects on stunning performance. However, it was considered that alternative waveforms would reduce the risks of detrimental affects on product quality although why and how remained obscure (Wilkins et al., 1998). Several alternative wave designs based on an AC square wave were evaluated in a short series of measurements on individual birds under controlled laboratory conditions. The two most promising designs were examined further in a second series of controlled measurements (section 4).

The standard procedure of hanging the live birds in shackles is considered by several experts as unacceptable or undesirable in terms of animal welfare (Fernandez, 2004). The shackles are also, as mentioned previously, a source of resistance and as such an additional risk to the success of the stun. It is known that the flow routes of electrical currents through the birds can vary between birds. In particular, the varying resistivity of the skull bone affects the amount of current reaching the brain (Woolley et al, 1986a).

It has been reported (Lambooi, et al 2008 b) that delivery of the electrical current via an alternative route could have several advantages. One such potential alternative (head-to-cloaca) route was investigated in a series of laboratory measurements (section 5).

Scientists have long been searching for alternatives to electro-narcosis. Transcranial Magnetic Stimulation (TMS) is a recently developed non-invasive technique used in the field of human psychiatry to treat depression in humans. In practice a single or double probe containing a copper coil is placed on the skull and an electric current charged by a TMS generator induces the magnetic stimulus within the surface cortex of the brain. Several measurements were performed under controlled laboratory conditions on individual broilers (section 6). These investigations were performed in co-operation with scientists from the University of Bristol (UK), using a prototype device¹.

Precise measurement of the true settings and amount of current delivered to the animal during an electrical stun has been a challenge to scientists for a considerable time. Not only is it a challenge to scientists but also to those in the industry who wish to guarantee an effective stun. In order to improve the conditions for stunning and sustainability of product quality it is essential to regularly monitor the amount of electricity being administered to each individual bird. Therefore, efforts have been made to develop a stand alone measuring device that can be placed in line next to birds in the water bath to measure currents, voltages, waveform and frequency during different runs after priming the device to a chosen level of resistance. A description is given of the device and the first data are presented in section 7.

1.2 Background information.

A basic understanding of electricity and in particular the concepts of voltage, current and resistance (or impedance) is essential to the interpretation of the results from this project. The relationship between current and resistance is described in Ohm's law usually presented as :

$$V = I * R$$

Where:

V = voltage, expressed in volts,

I = current, expressed as amperes,

R = resistance (or impedance), expressed as ohms (Ω).

In a parallel electrical circuit the true or total resistance (R_v) is equal to the sum of all resistance encountered along the parallel circuit:

This R_v is then calculated as:

$$1/R_v = 1/R_1 + 1/R_2 + \dots + 1/R_n$$

Therefore in practice :

Where the current becomes the result or response to a set voltage application divided by the total resistance (R_v).

$$I = V/R_v$$

This total resistance differs per bird resulting in different current requirements per individual bird to provide an effective stun.

¹ University of Bristol, UK

2 Present situation of electrical stunning of poultry in the Netherlands.

2.1 Introduction

Much national and international research during the 1980's was focused on the efficacy of stunning poultry. Unfortunately, all these studies did not produce a uniform opinion concerning the most satisfactory levels for stunner settings. However, it has become generally accepted and recommended that each broiler should be stunned with a minimum of 100 mA when using a water bath.

It is generally considered that under practical conditions when applying the recommended stunning level approximately 10-33% of the birds are inadequately stunned (Woolley et al, 1986 a,b). An additional disadvantage of this relatively high current application is the detrimental effect on meat quality. During electrical stunning muscle cramps affect the blood supply of the broiler in such a way as to cause excessive haemorrhaging or speckling of the meat (Kranen, 1999). Therefore, demand is increasing for alternatives which can ensure effective stunning without deterioration in product quality.

The central nervous system (CNS) is particularly sensitive to frequencies between 100- 300 Hz and muscles are sensitive to frequencies between 30 – 50 Hz. Administration of higher frequencies stimulates the CNS and to a lesser degree the muscles, causing less intense cramping. Yet more cramps occur due to a decrease in the ability of the muscles to cushion these effects. Prior to our investigation it was considered that frequencies between 200 – 400 Hz are generally being used and occasionally, the stunning current is increased up to 1500 Hz. It was considered that some slaughterhouses may even use frequencies of between 3000 – 4000 Hz in attempts to avoid haemorrhaging at the cost of a successful stun.

An investigation of the present situation in slaughterhouses was envisaged in order to assess the state of slaughter procedures in relation to the requirements based on current recommendations (EFSA, 2004, 2006) and legislation (NL, GWvD 1992; besluit doden van dieren 1997, EU directive, 1993, EC council, 2005). The main aim of the inventory was the measurement of relevant parameter settings such as voltage, amperages and frequencies at water bath level.

2.2 Materials and methods

2.2.1 First round of visits

In the period between October 2007 and January 2008 an inventory was made of the current situation of water bath stunners in 10 Dutch slaughterhouses. Of those visited six were specialised in broilers, two in the slaughter of hens and two establishments specialised in slaughtering ducks. Information was obtained from the slaughterhouses participating and readings were taken of the technical stunner settings. During this first round of visits measurements were performed using a hand-held oscilloscope.² The probe used to measure the current (mA) and voltages (V) was placed at points on the shackle and directly adjacent to the water bath.

2.2.2 Second round using in line measuring device

During November 2008 to January 2009 eight of these establishments were revisited (one duck, one hen and 6 broiler slaughterhouses). This time a purpose-made stand alone measuring device (see section 7 of this report for a detailed description) was used for measurements in the slaughter line during the stunning process through the water bath.

2.3 Results

2.3.1 First round

In six broiler slaughterhouses, stunner settings varied between 35 -153 V at frequencies ranging between 133 – 1000 Hz. Unfortunately, measurements at the water bath were only possible in three of the six slaughterhouses for broilers because of the risk to personal safety. Of the three measurements two were measured at 165 mA and the third at 250 mA. Both of which are above the recommended levels and above our estimates based on the settings of the slaughterhouses' own meters.

² Fluke, ...NL.

One establishment visited stunned hens using high frequency (2000 Hz) electricity set at 75 V which was estimated to provide a current of 115 mA to each hen. Measurement at different points on the shackle showed a current above the estimated current (200 mA).

Reading of the frequency meter was impossible at a second slaughterhouse where old layers were slaughtered. However, measurement of the current at the shackle showed an average current of 288 mA. This was more than double the estimate (125 mA) based on stunner voltage setting and numbers of birds simultaneously hanging in the water bath.

In addition two establishments were visited that slaughter ducks. Here the frequency settings differed (50 and 398 Hz) considerably between locations. It was possible to take readings of measurements at the shackles in both establishments. In one slaughterhouse, the current measured was 220mA and at other the measured current was 127 mA.

A summary of the data compiled during both rounds of visits is shown in Table 2.1..

Table 2.1 Technical characteristics of water bath stunners measured during two visits to a selection of Dutch slaughterhouses.

Date	number locations	Birds in bath	Duration Sec	Freq. Hz	Current mA	Voltage V	Impedance Ω
Oct07-Jan08	10	4 - 27	4 -16	50 - 2000	20 -133 ¹	35 – 250	650 - 2170
Dec08-Jan09	8	15 - 27	11 - 33	50 - 2000	24 – 216	60 – 202	920 - 2630

1 reliable current measurement only possible in six slaughterhouses due to concerns for personal safety.

2.3.2 Second round with in line measuring device.

The second round of visits resulted in similar levels of variation to that seen during the first round of visits. The numbers of birds simultaneously present in the water bath (see table 2.1) and the average duration in the bath showed considerable variation between locations. Measurement of frequency levels voltage and impedance were all performed using a prototype stand alone measuring device as described in section 7. The recorded levels of current yet again displayed considerable variation. Although this time measurements were performed in the shackles and in all eight slaughterhouses .

2.4 Conclusions.

Large differences were observed between slaughterhouses in the settings for water bath stunning parameters for broilers, hens and ducks. The varying numbers of birds present in the water bath simultaneously lead to variation in stunning duration.

3 Controlled laboratory measurements with individual birds

3.1 Introduction

Much diversity exists in electrical settings using water bath stunning. Parameters such as frequency, voltage, current waveform, resistance of the apparatus, resistance of the birds and dimensions of the water bath all influence the success of the stun.

Here we describe the results of measurements to investigate the effects of the technical settings encountered in the survey of Dutch slaughterhouses (section 2). During these measurements the effects on the onset of unconsciousness and the time taken to regain consciousness or not were also recorded for each bird. The consequences of the technical settings for carcass quality (blood splashing) were also examined in broilers.

3.2 Materials and methods.

3.2.1 *Animals.*

Eight batches of broilers (n=147 broilers in total) were obtained from a commercial slaughterhouse for the individual measurements. Four batches of ducks (n=75) were obtained from one of the slaughterhouses specializing in duck slaughter. The hens used for this study were provided by the poultry research unit in Lelystad (38 hens) and by a commercial free-range producer (45 hens).

During this study all individual stunning measurements involving live animals were performed with approval of the ethical committee on animal experiments (DEC) of the Animal Sciences Group of Wageningen UR, in Lelystad.

3.2.2 *Experimental design*

During the period from March to October 2008, several series of measurements were performed using broilers, hens and ducks under controlled laboratory conditions at the research facilities of Wageningen UR (Animal Sciences Group (ASG), Lelystad, The Netherlands).

All individual measurements were performed using an AC voltage stunner (type: IMARES, Lambooj et al, 2008) producing a variable current which was measured at point of entry to the water bath using an AC/DC current probe (type A622, measurement range 50 mA – 100 A) connected to an oscilloscope³.

All stuns were performed using a modified square AC wave. Broilers and hens were stunned at frequencies of 50, 400 or 1000 Hz and ducks at 50 and 400 Hz (1000 Hz not being used in practice according to results from survey). All stuns were performed to assess the efficacy of regulatory current levels (i.e. 100 mA at 50Hz for broilers or 130mA for ducks) or adapted in relation to frequency to produce a current that would provide an effective stun.

3.2.3 *Brain and heart activity*

In order to determine loss of consciousness heart and brain activity were measured. For the registration of the electro-encephalogram (EEG) two needle electrodes⁴ (55% silver, 21% copper, 24% zinc) of 10 mm length and a diameter of 1.5 mm were positioned under the skullcap by pressing through the skin and skull onto the brain lobes 0.3 cm left and right of the sagittal suture and 0.5 mm towards an imaginary transverse line at the caudal margin of the eyes. The electrodes were fixed with medical tape. To register heart rate (as beats per minute: bpm) and rhythmic disorders two needle electrodes (same metal composition as above) of 35 mm in length and 1.5 mm in diameter were placed subcutaneously at the left and right side of the chest under each wing. In order to minimize signal distortion an earth connecting electrode was placed subcutaneously in the dorsal region of the bird. The electrodes were connected to a registration and recording device using isolated and coaxial shielded wires. The micro voltage signals of the brain and heart were amplified using a bio-medical amplifier (BMA)⁵ and continuously recorded using Windaq computer software⁶.

³ Tektronix, Inc., P.O. Box 500, Beaverton, OR 97077, USA: model TDS2024.

⁴ Engelhard-CLAL, New Jersey, USA

⁵ MODEL BMA-931, CWE, Inc., Ardmore, USA

⁶ DATAQ instruments, Akron Ohio, USA.

After adjustment of the waveform generator⁷ a stun was performed with the chosen waveform at a set frequency delivered for the required duration.

To determine unconsciousness, the response of each animal to a pain stimulus (comb pinching) was observed at 30 seconds, 1 minute, 2 minutes and each minute thereafter up to a maximum of 5 minutes after onset of stunning. This process was terminated after two consecutive positive reactions to limit the amount of distress to the bird.

Upon completion of the observation period the animal was stunned again and immediately (<20 seconds) bled by neck cutting. After bleeding for 2-3 minutes each bird was weighed using a digital weighing scale⁸. Thereafter, in the case of broilers, carcasses were examined for signs of blood splashing in the breast and leg muscles.

The EEG recordings were analysed for changes in frequency and in amplitude. Changes in EEG frequency, more specific the suppression of alpha (8-13 Hz) and beta (>13 Hz) waves and the occurrence of theta (4-8 Hz) and delta (<4 Hz) waves are indicative for loss of consciousness. Suppression of the theta and delta waves, minimal brain activity, will lead to an irreversible iso-electric EEG.

The ECG recordings were analysed for cardiac arrest, or more specific the absence of heart rate.

The physiological state of the birds after exposure to a electrical stunning current was judged based on electro physiological parameters as well as on behavioural reactions, or reactions to pain stimuli.

Unconsciousness is defined as follows:

- suppression of high EEG frequencies.
- No response to pain stimuli (comb pinching).
- No eyelid or cornea reflex

Recovery is defined as follows:

- re-occurrence of alpha and beta waves. The EEG signal returns to the same pattern as before stunning.
- Response to comb pinching
- Controlled eye movements (following) and cornea reflex.

Death is defined as follows:

- absence of heartbeat on the ECG trace
- iso-electric EEG

3.2.4 Statistical analysis.

This study was analysed as a split-plot design using statistical software (Genstat, 2008). This involved different combinations of poultry type (broiler, hen or duck) and frequency (50, 400 or 1000 Hz) distributed within date of execution.

The analysis was divided into two processes, i.e.

- 1). The influence of voltage (x) on current requirement (mA) per bird (y); individual variation in mA being caused by variation in impedance between birds.
- 2). Effect of eventual current (mA) passing through the bird (x) on the chance that the animal is successfully stunned (y). The chance of a successful or unsuccessful stun is considered to be a binomial characteristic (yes/no).

Schematic:

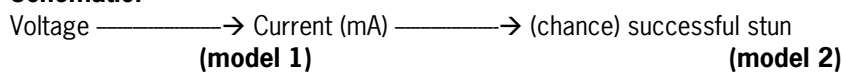

Models based on current levels.

$$(Y_{ijk}) = \beta_0 + (\beta_1 + \delta_i + \lambda_j) * X + \rho * GEW_{ijk} + \epsilon_{dag} + \epsilon_{ijk} \quad (\text{model 1a})$$

Y_{ijk} current level of the k-th bird of type i, at frequency j

β_0 Intercept: current estimated at voltage = 0 at bodyweight 0.

β_1 Increase in current per unit increase in voltage; model parameterization is such that β_1 is estimated for reference bird type 'broilers' at a reference frequency of '50 Hz'.

δ_i Deviations in current level increase per voltage unit for alternative bird types i; category 2=duck; category 3=hen.

⁷ Agilent 33220A, Agilent technologies inc., Santa Clara CA, USA

⁸ Toledo ID7, Mettler (Albstadt) GmbH, D-72458 Albstadt, Germany

λ_j Deviations in current level increase per voltage unit for alternative frequency steps j ; step 2=400 Hz; step 3=1000 Hz.

X Voltage level set for each stun per individual bird.

ρ Increase in current per extra unit of body weight per individual bird.

GEW_{ijk} Body weight (in kg)

$\underline{\epsilon}_{dag} \sim N(0; \sigma_{dag}^2)$ Random effect of day of measurement (i.e. variation between groups)

$\underline{\epsilon}_{ijk} \sim N(0; \sigma_{ijk}^2)$ Residual variation (incl. measurement errors and individual animal effects).

$(\underline{Y}_{ijk}) = \beta_0 + (\beta_1 + \delta_i + \lambda_j) * X + \underline{\epsilon}_{dag} + \underline{\epsilon}_{ijk}$ (model 1b)

Where: \underline{Y}_{ijk} current level of the k -th bird of type i , at frequency j

β_0 Intercept: current estimated at voltage = 0 .

β_1 Increase in current per unit increase in voltage; model parameterization is such that β_1 is estimated for reference bird type 'broilers' at reference frequency of '50 Hz'.

δ_i Deviations in current level increase per voltage unit for alternative bird types i ; category 2=duck; category 3=hen.

λ_j Deviations in current level increase per voltage unit for alternative frequency steps j ; step 2=400 Hz; step 3=1000 Hz.

X Voltage level set for each stun per individual bird.

$\underline{\epsilon}_{dag} \sim N(0; \sigma_{dag}^2)$ Random effect of day of measurement (i.e. variation between groups)

$\underline{\epsilon}_{ijk} \sim N(0; \sigma_{ijk}^2)$ Residual variation (incl. measurement errors and individual animal effects).

Model to indicate success of stun:

$Logit(\underline{Y}_{ijk}) = (\beta_0 + \alpha_i) + (\beta_1 + \delta_i + \lambda_j) * S + \underline{\epsilon}_{dag}$

Where: \underline{Y}_{ijk} Chance of successful stun of the k -th bird of type i , at frequency step j

β_0 Intercept: estimated stun chance at current = 0 mA ; model parameterization is such that β_0 is estimated for reference type 'broilers' at reference frequency step '50 Hz'.

α_i Difference level at intercept (on logit scale) for stun chance of alternative bird type i ; category 2=duck; category 3=hen.

β_1 Increase in stunning chance (on logit scale) per unit (mA) increase in current; model parameterization is such that β_1 is estimated for the reference bird type 'broilers' at reference frequency step '50 Hz'.

δ_i Deviations in stun chance increase per mA for the alternative bird category i ; category 2=duck; category 3=hen.

λ_j Deviation in stun chance increase per unit mA for an alternative frequency step j ; step 2=400 Hz; step 3=1000 Hz.

S Current level (in mA) measured during stun of each individual bird.

$\underline{\epsilon}_{dag} \sim N(0; \sigma_{dag}^2)$ Random effect of day of measurement (i.e. variation between groups)

Residual variation (incl. measurement errors and individual animal effects), following the stun chance (but variation of an individual observation is : $p(1-p)$).

3.3 Results.

A summary of the results of these experiments is shown in table 3.1.

Table 3.1. Technical settings (voltage and current mA) measured, electrical resistance (kΩ) estimated and body weight (kg) measured per animal and numbers and percentage of birds that died during electrical stunning (modified square AC wave; varying frequency). Experiments with broilers, hens and ducks in a single bird water bath.

	Voltage ¹		Current measured (RMS)	Resistance ²	Body weight	Dead birds	
	Input	Output	mA	kΩ	Kg	N	%
BROILERS							
Frequency 50 Hz.							
Average	162	167	114	1.5	2.4		
Max	223	212	229	3.8	3.2		
Min	120	116	45	0.9	1.7		
Sd	37.7	35.1	44.0	0.60	0.36		
N	51	38	51	51	51	47	97.9
Frequency 400 Hz.							
Average	221	212	174	1.4	2.6		
Max	260	296	274	3.9	3.5		
Min	130	124	54	0.9	2.0		
Sd	49.5	56.9	56.2	0.50	0.39		
N	46	33	46	46	46	22	47.8
Frequency 1000 Hz.							
Average	293	279	245	1.3	2.3		
Max	402	384	444	2.6	3.5		
Min	130	124	65	0.8	1.8		
Sd	103.2	92.9	125.8	0.43	0.38		
N	50	50	48	48	49	13	27.0
HENS							
Frequency 50 Hz.							
Average	208	221	87	2.8	1.9		
Max	239	276	151	5.0	2.4		
Min	150	149	40	1.3	1.3		
Sd	30.4	38.6	27.8	0.81	0.24		
N	26	39	39	39	39	17	44
Frequency 400 Hz							
Average	210	218	83	2.7	1.9		
Max	261	306	136	4.0	2.2		
Min	150	149	48	2.1	1.6		
Sd	44.92	55.46	26.87	0.48	0.20		
N	18	18	18	18	18	1	6
Frequency 1000 Hz							
Average	221	220	102	2.5	2.0		
Max	300	290	219	4.7	2.4		
Min	150	150	43	1.3	1.7		
Sd	56.1	52.1	51.3	0.82	0.21		
N	19	19	19	19	19	0	0

DUCKS	Frequency 50 Hz						
Average	248	242	156	1.6	2.9		
Max	350	333	243	2.3	3.8		
Min	150	150	77	1.1	2.0		
Sd	64	83	49	0.27	0.39		
N	44	19	44	44	43	18	41
Frequency 400Hz.							
Average	263	259	160	1.8	3.0		
Max	400	382	362	2.8	3.7		
Min	150	153	64	0.9	2.4		
Sd	96	103	79	0.43	0.37		
N	31	22	18	30	30	3	10

1 = numbers of recordings of voltage output can be lower than input due to failure of recording instruments. 2 = resistance calculated as output voltage (input used where reading for output is unavailable) divided by measured RMS current.

3.3.1 Broilers.

Broilers stunned at a frequency of 50Hz (see Figure 3.1) displayed currents ranging between 45-229 mA which on average(\pm sd) (114 ± 44 mA) was above the recommended level for an effective stun.

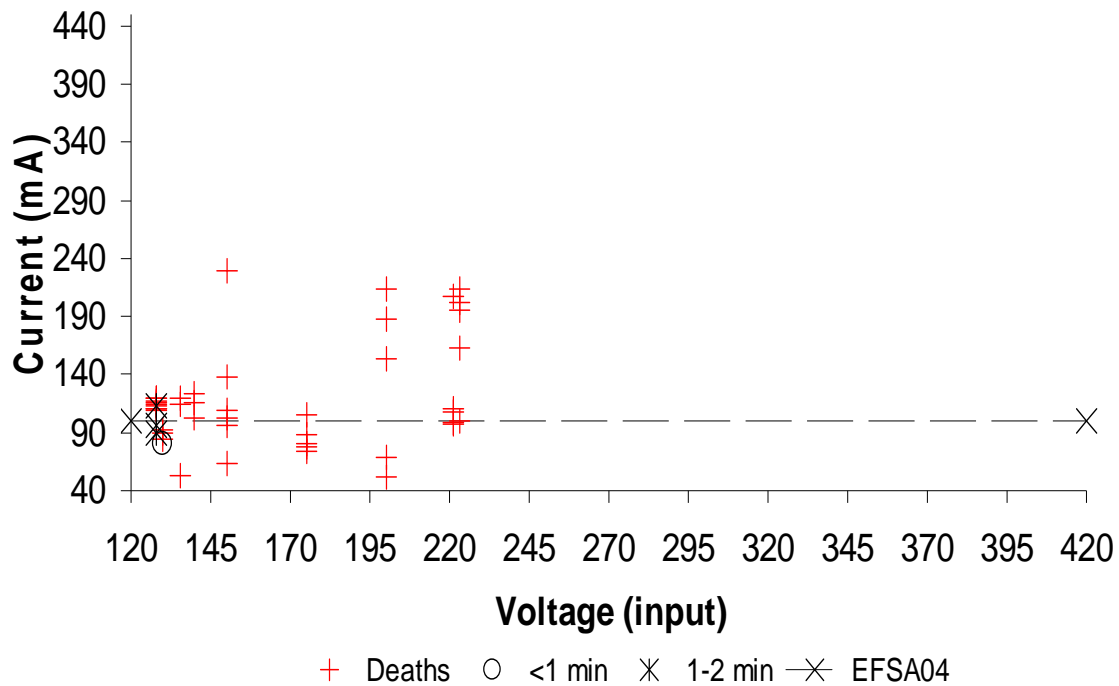

Figure 3.1 Recovery of broilers (O and X) and number of broilers that died (+) after being stunned for 5 seconds with a modified square AC wave, frequency 50 Hz (EFSA = guideline level of current for effective stun).

The results (figure 3.1) demonstrate that almost all (except one recovery at less than 1 min) of the broilers were effectively stunned. However, more than 90% died including some stunned below the EFSA recommended (100 mA) current level. Three of the 20 broilers that received currents below the EFSA recommended level were rendered unconscious for 1-2 minutes. The remaining 17 died. Electroencephalographic (EEG) and electrocardiographic (ECG) data supported these findings.

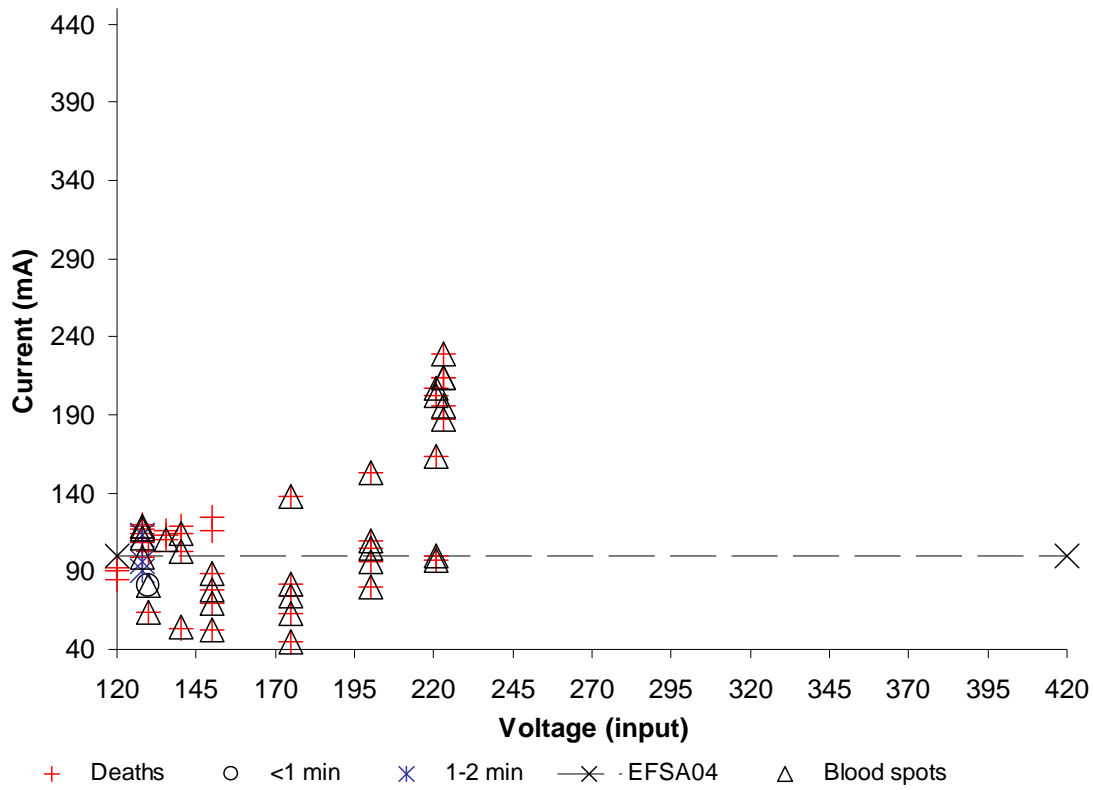

Figure 3.2 Incidence of blood spots (Δ) in muscles (breast and /or thigh) of broilers after being stunned for 5 seconds with a modified square AC wave, frequency 50 Hz (EFSA = guideline level of current for effective stun).

Inspection of the carcasses of the broilers stunned at 50Hz revealed that 67% of the broilers displayed blood spots (see Figure 3.2). The broilers that revealed bloodspots (indicated by a triangular symbol) were stunned in a range from 45-240 mA of these 29% (n=15) received a current below the EFSA recommendation level.

Broilers stunned at 400 Hz received on average(\pm sd) 174(\pm 56) mA (range 54 – 274 mA) which was above the recommended application level (150 mA) for an effective stun.
 Approximately 48% of the broilers stunned at 400 Hz died (range: 150 – 275 mA) all of which received a current above the recommended 150 mA. Those stunned at voltages below 200 V remained conscious or recovered within a minute. Of the 13 broilers stunned below the recommended level 10 remained unconscious for 1 – 3 minutes (see Figure 3.3).

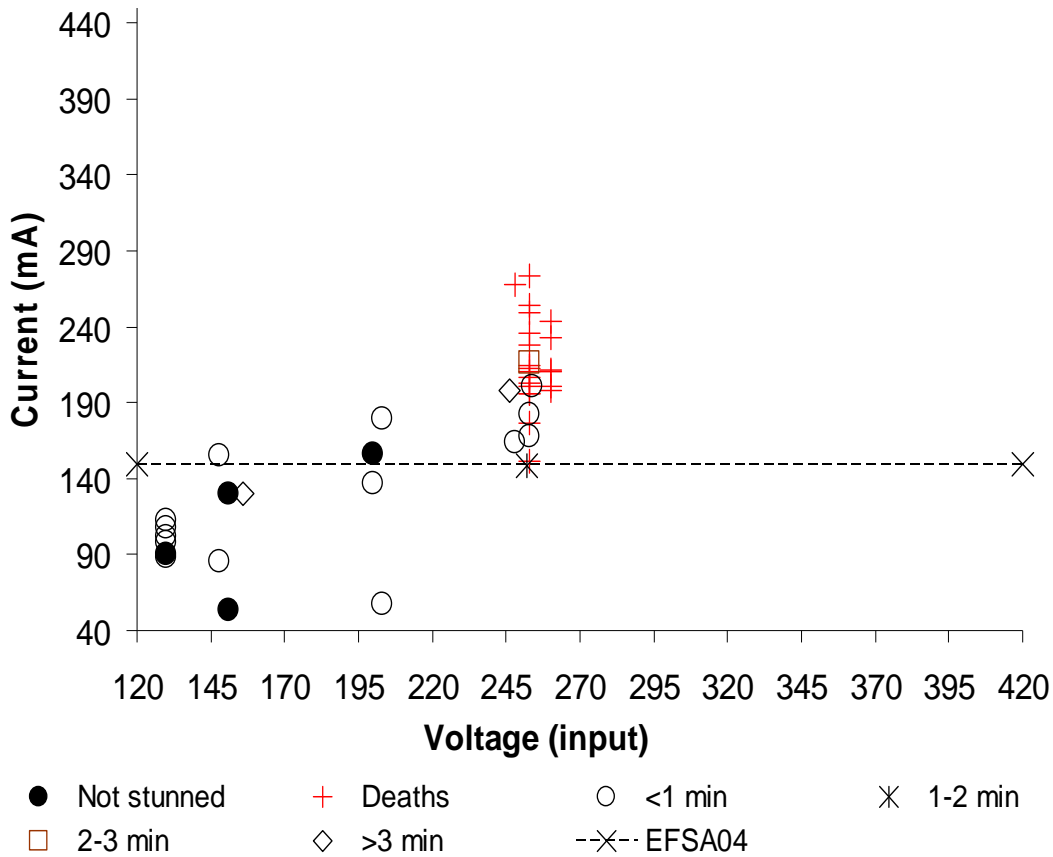

Figure 3.3 Broilers, not stunned (●), recovery times (○, *, □, ◇) and numbers that died (+) after being stunned for 5 seconds with a modified square AC wave, frequency 400 Hz (EFSA = guideline level of current for effective stun).

Four broilers remained conscious after the stun (indicated as ● in figure 3.3), one of which received a current above the EFSA recommended level. This reason for the retention of consciousness remains unclear.

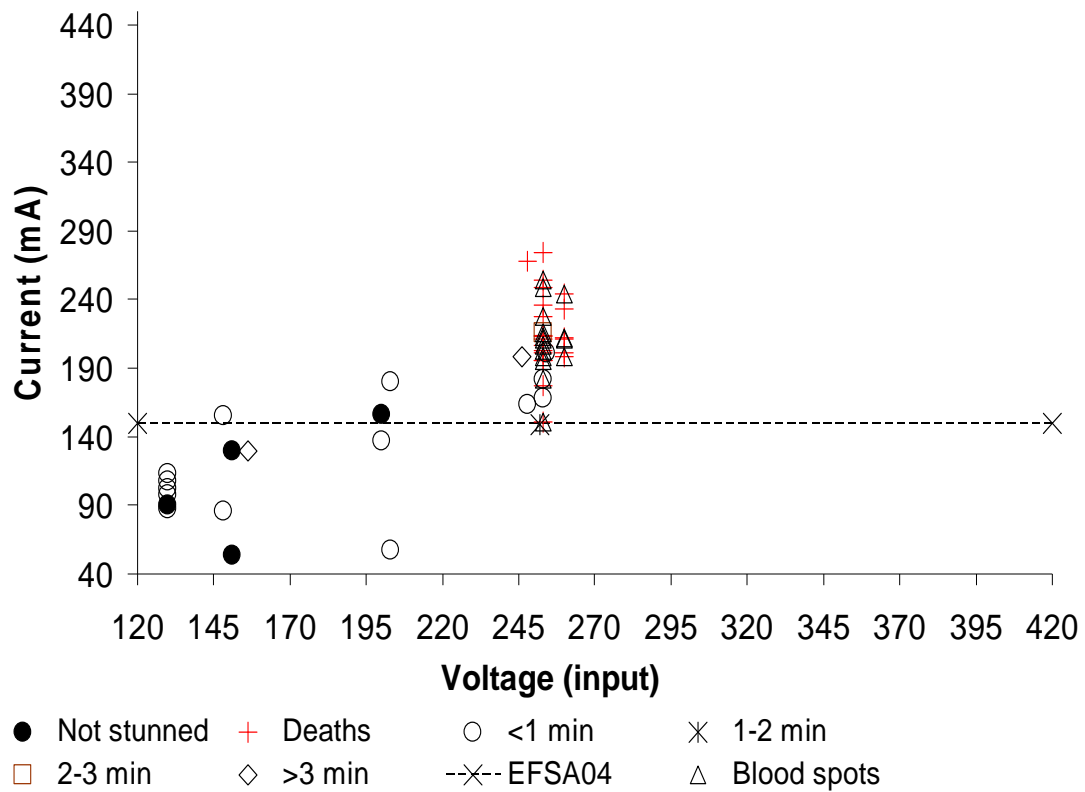

Figure 3.4 Incidence of blood spots (Δ) in muscles (breast and /or thigh) of broilers after being stunned for 5 seconds with a modified square AC wave, frequency 400 Hz (EFSA = guideline level of current for effective stun).

Examination of the carcasses after bleeding revealed blood spots (indicated in Figure 3.4 as triangular symbol) in 35% of the birds (range: 150-250 mA). All carcasses displaying blood spots were from broilers stunned above the EFSA recommended level of 150 mA.

Broilers stunned at frequency 1000Hz received on average (\pm sd) 245 (\pm 126)mA.

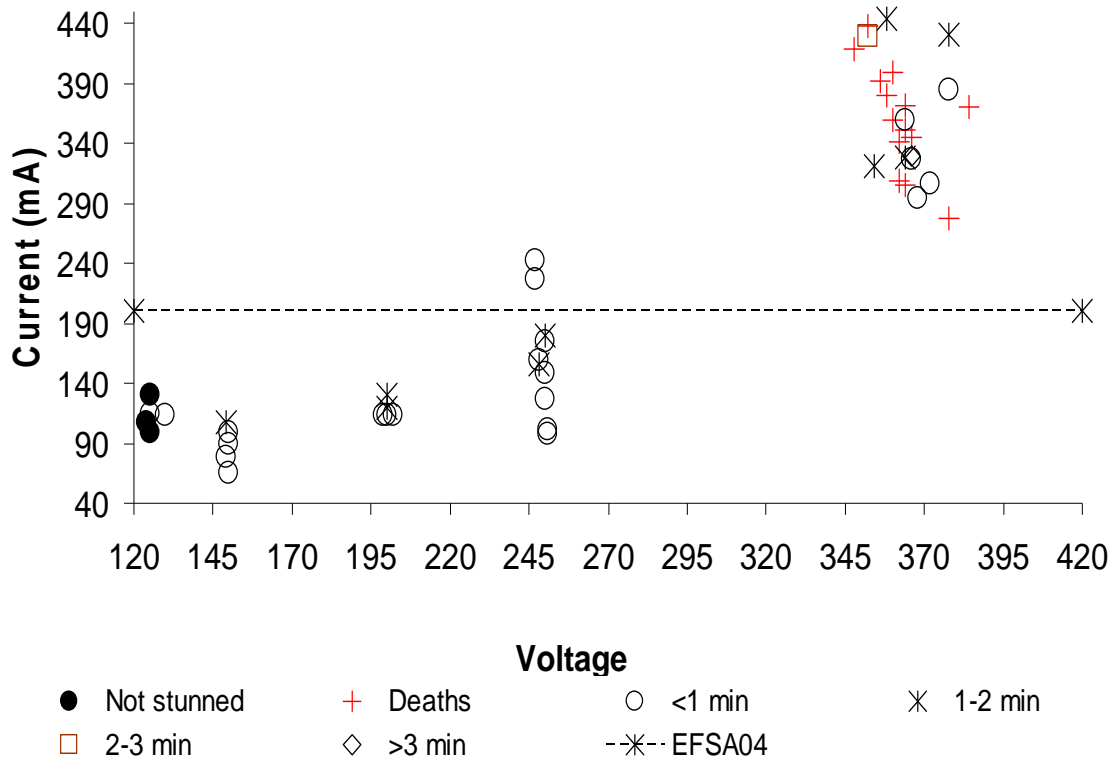

Figure 3.5 Broilers , not stunned (●), recovery times (○, ⊛, ⊠, ◇) and numbers that died (+) after being stunned for 5 seconds with a modified square AC wave, frequency 1000 Hz (EFSA = guideline level of current for effective).

In figure 3.5 it can be seen that after stunning for 5 seconds at a frequency of 1000 Hz that 3 animals were not effectively stunned (●) or that 22 responded to a pain stimulus within 1 min (°) . Those broilers given a stun above 250 V and receiving a current above 240 mA did not respond to a pain stimulus within 1-3 minutes or died (31%). Those receiving currents around the recommended 200 mA at 145-245 V did not respond to comb pinching for between 1-2 minutes. Broilers (n=23) stunned at currents below the recommended level, particularly below 130 V reacted immediately (n=3) or took up to 2 minutes to react to comb pinching.

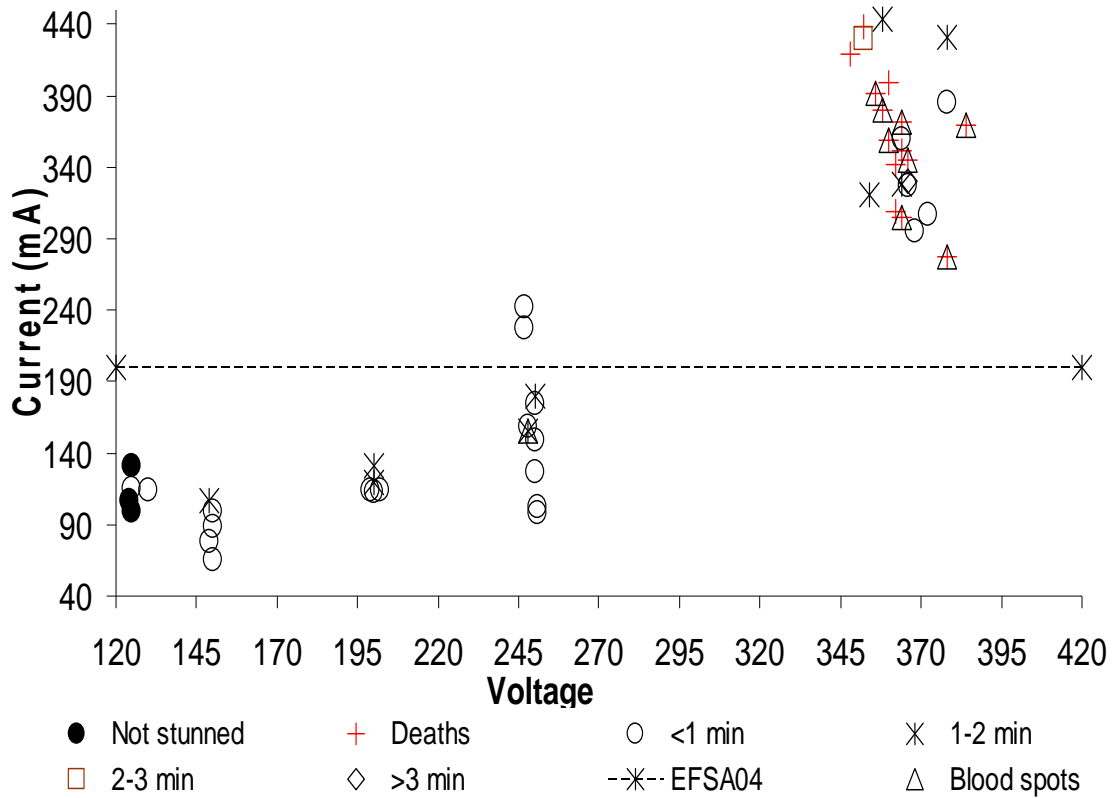

Figure 3.6 Incidence of blood spots (Δ) in muscles (breast and /or thigh) of broilers after being stunned for 5 seconds with a modified square AC wave, frequency 1000 Hz (EFSA = guideline level of current for effective stun).

Blood spots (triangular symbols) were observed in 18% of the carcasses (Figure 3.6). Responses to comb pinching were within a short period (max. 2 min) up to 240 mA. Only after stuns in the range from 260-444 mA is there a longer interval (above 3 min and deaths) in response time. As seen with stuns at 50 and 400 Hz an effective stun often produces blood splashing in the muscle tissue of broilers.

3.3.2 Hens.

Hens stunned at 50 Hz (figure 3.7) displayed fewer incidences of death (44%) than broilers at 50 Hz (figure 3.1). Nine of the birds that died were stunned at currents below 100 mA. Approximately 46% (n=18) of the birds stunned at 50 Hz displayed intervals of 1 – 2 minutes prior to a pain stimulus response. Of these, 16 were stunned below the recommended level (100 mA). Fifteen of these hens responded to a comb pinch within 1 minute.

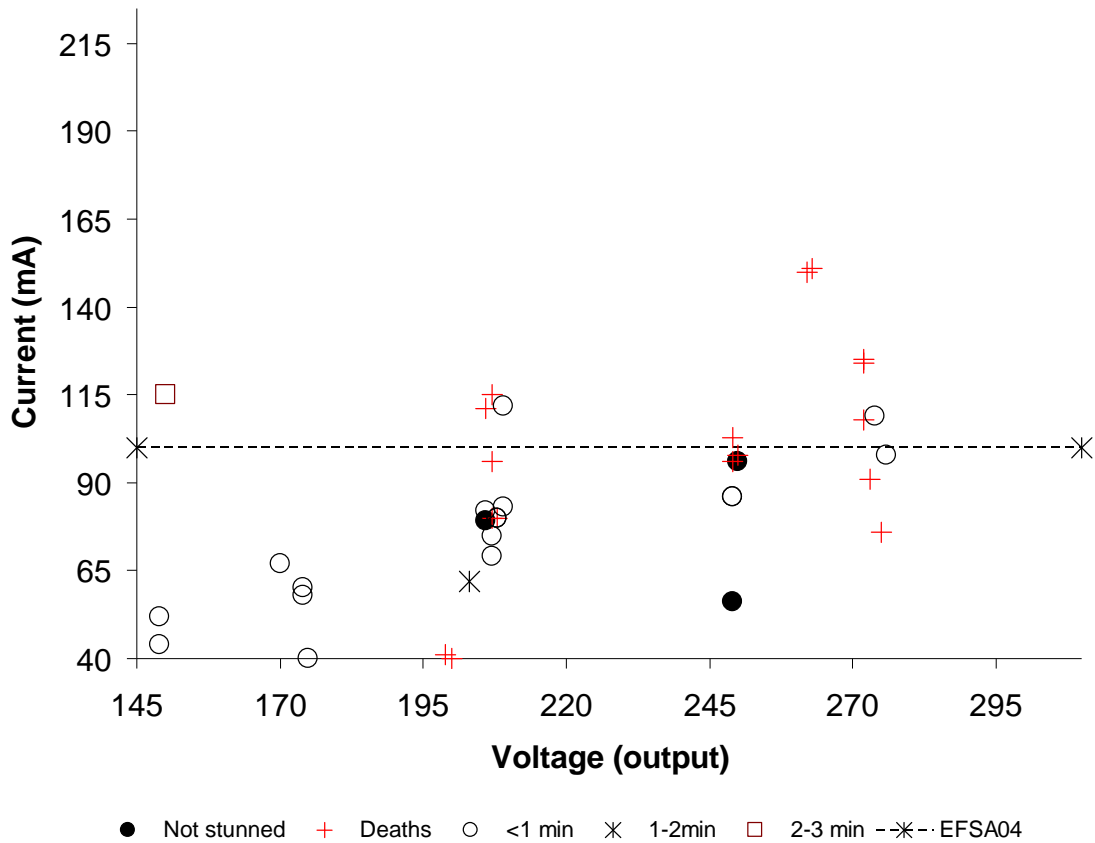

Figure 3.7 Hens, not stunned (●), recovery times (○, *, □) and numbers that died (+) after being stunned for 5 seconds with a modified square AC wave, frequency 50 Hz (EFSA = guideline level of current for effective).

Hens stunned at a frequency of 400 Hz (see figure 3.8) received on average (\pm sd) $83(\pm 27)$ mA. All of which (range: 48-136 mA) were below the EFSA recommendation of 150mA.

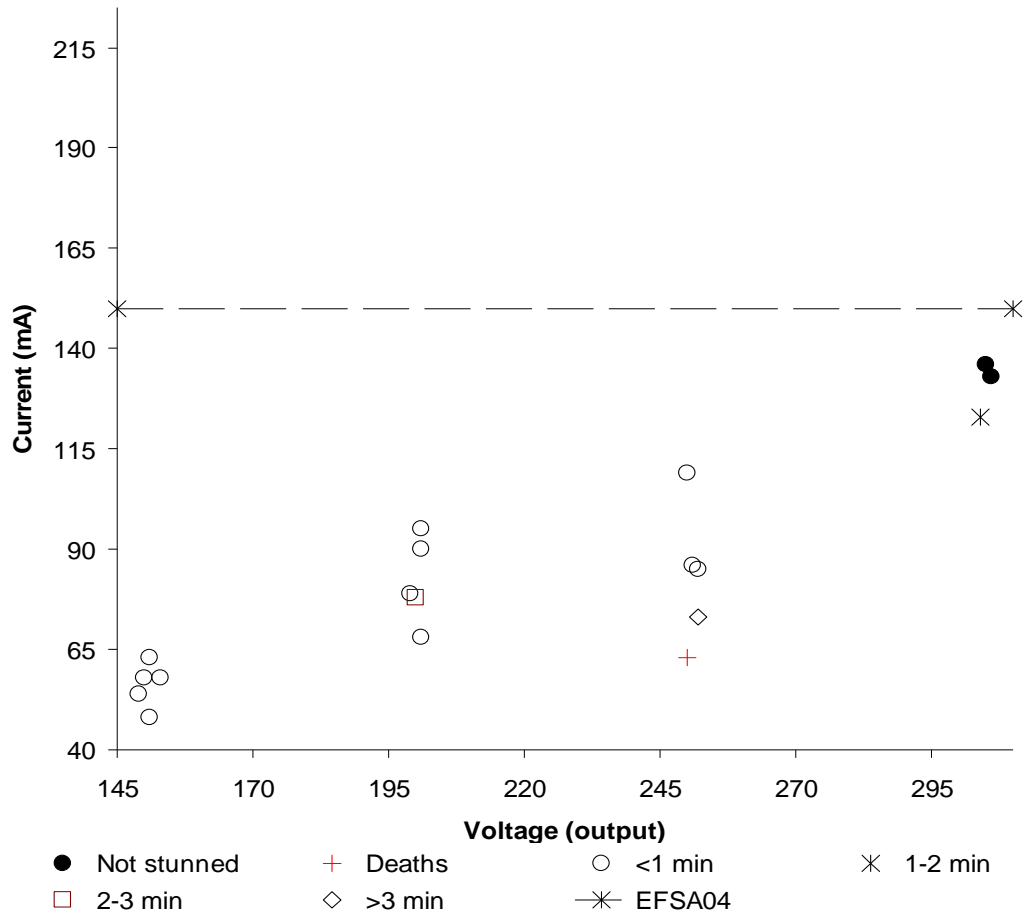

Figure 3.8. Hens, not stunned (●), recovery times (○, ✖, □, ◇) and numbers that died (+) after being stunned for 5 seconds with a modified square AC wave, frequency 400 Hz (EFSA = guideline level of current for effective).

Although all stuns were performed at current levels below the recommended levels 14 of the 18 broilers (78%) stunned at 400Hz remained conscious (n=2) or regained consciousness within a minute after stunning. Only four hens stunned at 400Hz took longer than a minute to regain consciousness, one of which died.

Hens stunned at a frequency of 1000 Hz (see figure 3.9) received on average (\pm sd) 102(\pm 51)mA.(range: 43-219 mA) . All but two hens were stunned below the EFSA recommendation of 200mA.

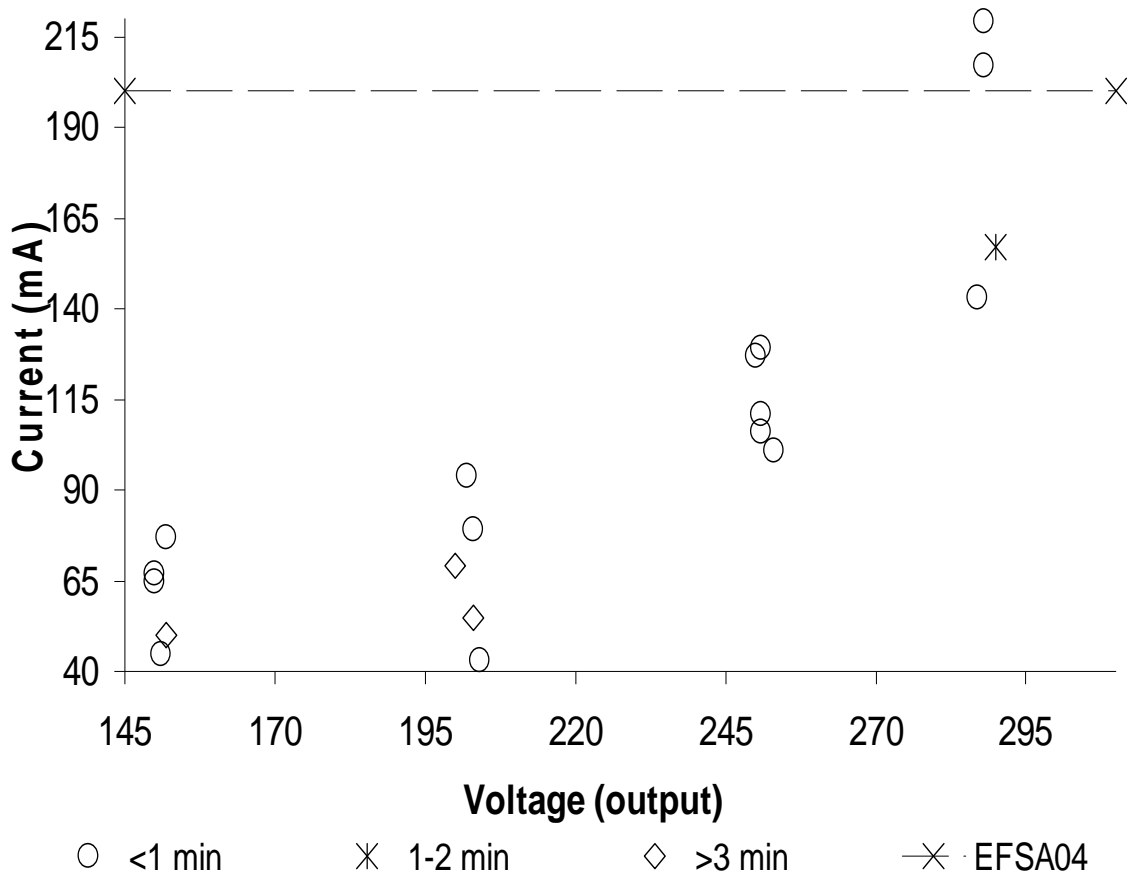

Figure 3.9. Recovery times (O, *, □, ◇) of hens after being stunned for 5 seconds with a modified square AC wave, frequency 1000 Hz (EFSA = guideline level of current for effective).

All animals were effectively stunned and approximately 80% (n =15) of the hens responded to a comb pinch within 1 minute at currents generally below the recommended 200 mA. Three hens receiving 50-69 mA took longer than 3 minutes to respond to a comb pinch (see Figure 3.9).

3.3.3 Ducks

Ducks (n=44) stunned at a frequency of 50 Hz (see figure 3.10) received on average (\pm sd) 156(\pm 49)mA (range: 77-243 mA). Approximately 25% (n=11) of the 50Hz stuns resulted in current levels below the EFSA recommendation of 130mA.

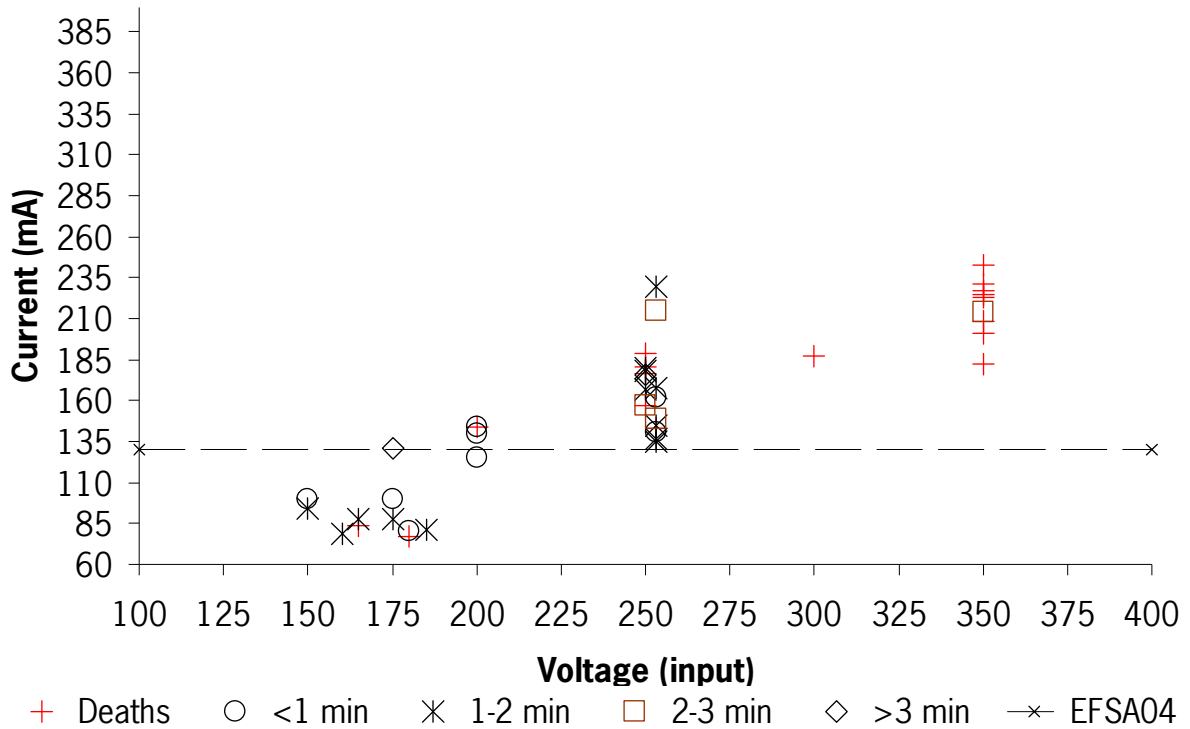

Figure 3.10. Ducks, not stunned (●), recovery times (○, ✕, □, ◇) and numbers that died (+) after being stunned for 5 seconds with a modified square AC wave, frequency 50 Hz (EFSA = guideline level of current for effective).

It can be concluded from figure 3.10 that although all ducks were successfully stunned, a large percentage (39%; n=17) displayed loss of heart beat during the allotted recovery period (max 3 minutes). A few (n=4) responded to a comb pinch between 2-3 minutes and one duck after the allotted recovery time of 3 minutes. It would appear that below the recommended application level of 130 mA the ducks were also effectively stunned i.e. 9 of the 11 birds responded within 2 minutes. Settings producing higher currents between 120 – 150 mA resulted in sufficient response times within 1 to 2 minutes after stunning. The majority of deaths occurred at currents ranging between 140-245 mA, although 2 ducks died at currents below 100 mA. Ducks stunned with a modified square AC wave at a frequency of 50 Hz at 200 V or above are less likely to regain consciousness.

Ducks (n=31) stunned at a frequency of 400 Hz (see figure 3.11) received on average (\pm sd) 160(\pm 79)mA (range: 64-382 mA). Approximately 35% (n=11) of the 50Hz stuns resulted in current levels below the EFSA recommendation of 130mA.

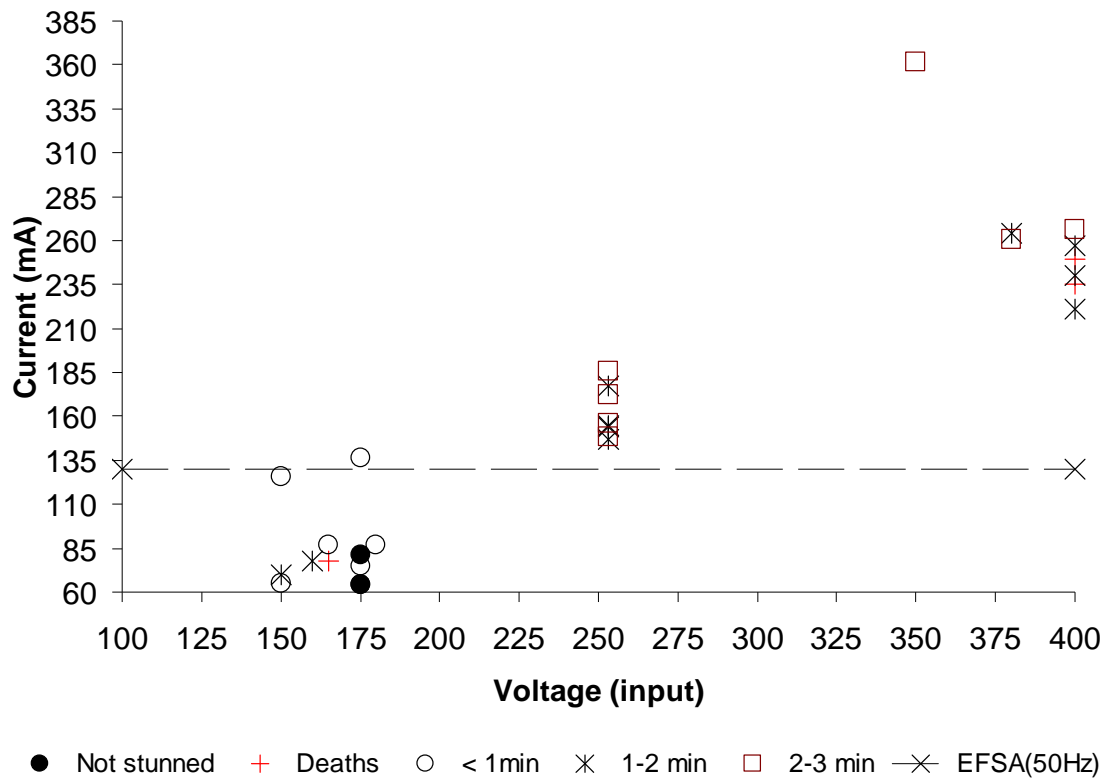

Figure 3.11. Ducks, not stunned (●), recovery times (○, ✱, □, ◇) and numbers that died (+) after being stunned for 5 seconds with a modified square AC wave, frequency 400 Hz (EFSA = guideline level of current for effective).

The results displayed in figure 3.11 suggest that at 400 Hz a current from 147 to 362 mA displayed sufficient numbers of effective stuns (response time 2 – 3 minutes). Two deaths occurred in the range 230-250 mA at higher voltage levels (\pm 400 V). Approximately 10% of the ducks stunned at 400 Hz displayed loss of heart beat and an iso-electric EEG and were considered to be dead.

3.3.4 Statistical analysis.

Model for current :

Broilers, hens and ducks received significantly ($P < 0.001$) different amounts of current at the same voltage levels. Hens especially display lower levels of current ($P < 0.001$). Additionally, at 1000 Hz the strength of the current is significantly ($P = 0.001$) lower than for the other two frequencies at similar voltage levels.

There is considerable variation between measurement days but also within a day of measurement. This is an indicator of potential impedance variation between groups of the same types of bird and a large variation in impedance within groups (between individuals).

Body weight bears no relationship to chance of a successful stun. Differences in body weight only represent a small proportion of the variation between groups (residual variation fell from 863 to 742) and generally the heavier birds within each group required a higher current at similar voltage levels. Although there is a slight effect attributable to body weight ($P < 0.001$), it is considered preferable to present a model excluding body weight (model 1b) and to demonstrate via a residual diagram (appendix 1; standardized residuals) the size of the residuals.

The 95% confidence limit of the expected current level for each individual bird is probably the best indicator of the variation in response. Within a group this interval can be computed as follows: $\pm 2 * s$ (square root of the residual variation). In this example this equates to ± 60 mA. In other words, for an average group 5% of the birds receive a current that deviates by ± 60 mA from the group average. The response in current levels in relation to voltage input is shown in figure 3.12 for broilers, hens and ducks .

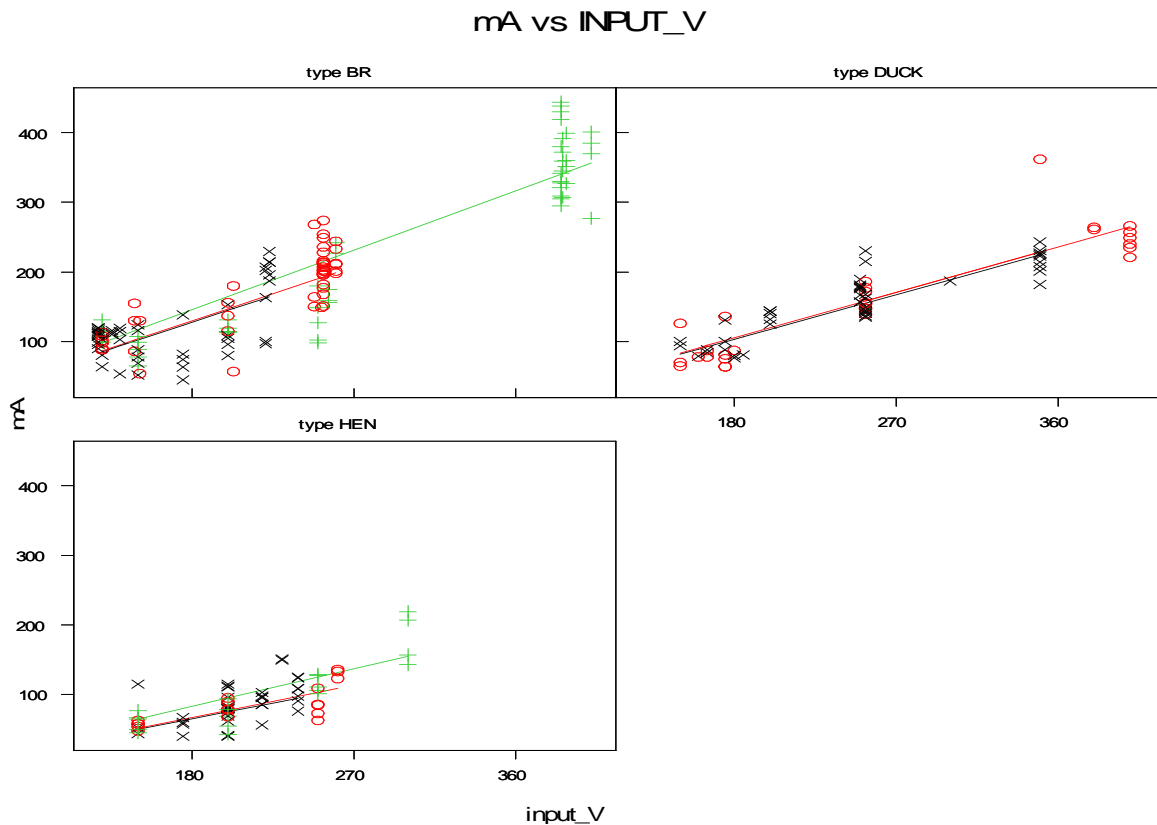

Figure 3.12. Response in terms of current (mA) to voltage (input_V) input observed during individual stunning of broilers and hens at frequencies of 50Hz (black line), 400Hz (red line) and 1000Hz (green line) and ducks at frequencies of 50Hz (black line) and 400Hz (red line).

Model for chance of stun success :

There is no significant difference in chance of a successful stun with either broilers, hens or ducks at similar currents.

There is a significant ($P < 0.001$) difference in the stun chance as function of the current level at different frequencies (Hz steps). Frequency 400 Hz has a lower intercept (chance of successful stun at very low currents) and at 1000 Hz displays a much lower increase in chance of success with increasing currents. This provides a much lower chance of success at 400 Hz and 1000 Hz by stuns performed at relatively lower currents.

It seems that there is considerable variation between days on which measurements were taken.

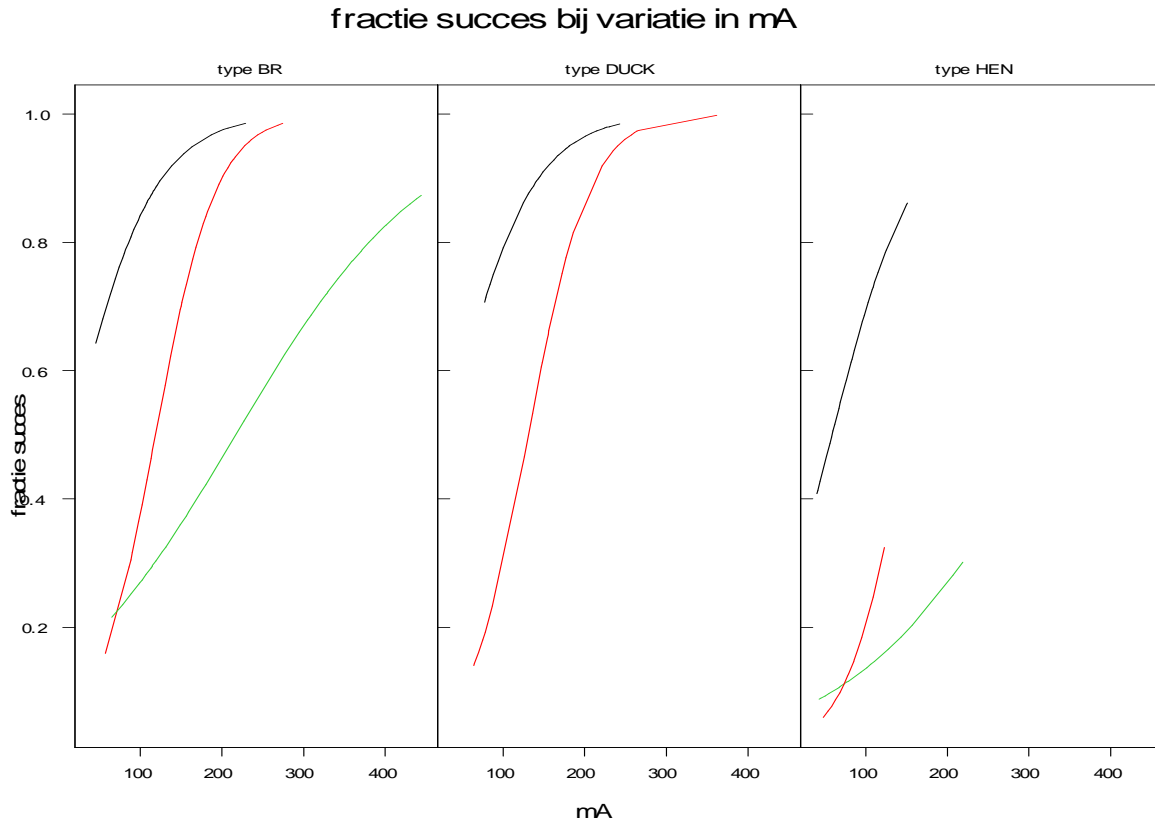

Figure 3.13. Probability (fractie succes) of successful stun in relation to current level (mA) based on observations from individual stuns with broilers, ducks and hens at frequency levels of 50 Hz (black line), 400Hz (red line) and 1000Hz (green line).

Present legislation requiring a current of 100 mA is based on a sinus wave form delivered with a frequency of 50Hz for at least four seconds. In practice, increasing use is being made of higher frequencies such as 400 and 1000Hz. It has been reported (EFSA, 2006, Raj, 2006) that higher frequencies require higher levels of current to induce an effective stun and results from this study confirm these findings. Furthermore, the results from this study lead the authors to question the acceptability of present recommendations for practical application. It is clear that effective stuns involving higher frequencies and higher currents result in blood splashing of muscle tissue. The indications are that effective stuns using the present conventional water bath method are almost certain to result in haemorrhaging.

3.4 Conclusions

Differences in current at similar voltages between individual broilers, hens and ducks or within groups indicate differences in impedance that influence the chance of an effective (water bath) stun.

Hens are adequately stunned at lower current levels than broilers at similar levels of voltage application. However, the chance of a successful stun at similar currents is not significantly higher in hens than in broilers.

Ducks display effective stuns at lower current levels than broilers at certain levels of voltage application.

Frequency affects the percentage successful stuns for ducks as well for broilers and hens. However, the chance of a successful stun at certain current levels does not differ between broilers, hens and ducks

There is large variation in impedance between individual birds. Body weight is not a reliable indicator for differences in impedance.

4 Alternative waveforms

4.1 Introduction

Many publications (Lambooij et al, 2008b; Savenije, et al., 2000; Gregory and Wotton, 1990; Gregory and Wilkins, 1989; Veerkamp and de Vries, 1983) have in recent years addressed the complex puzzle of combining a humane slaughter method with quality assurance of processed meat. The conflict between animal welfare and carcass quality continues. Alternatives are in demand and an alternative method (head-to-cloaca) has been presented (Lambooij et al., 2008b). Alternative wave forms have also been suggested (Lambooij et al., 2008b) as a potential improvement to both welfare and product quality risks.

In recent years, technology has developed to such a degree that it has become possible to create “clean” pulsed electricity for stunning animals or for electric shock treatment of depression in humans. It has been reported that ultimately, the amount of energy used for treatment on humans or stunning of certain types of fish (i.e. tilapia and sea bass) or stunning of broilers can be reduced in comparison to the requirement when using a sinus wave (Lambooij et al, 2008 a). However, optimum levels for operational parameters (i.e. pulse width, frequency and energy concentration) remain as yet unknown (see figure 4.1 description of the different parameters). It is hypothesized that use of alternative waveforms may lead to a reduction in carcass damage. Therefore, a series of controlled laboratory measurements was performed to select potential alternative waveforms and examine their potential efficacy in stunning broilers in a water bath. Neural and physiological aspects were evaluated after administration of several experimental waveform designs with broilers, as well as blood spots in muscle tissue.

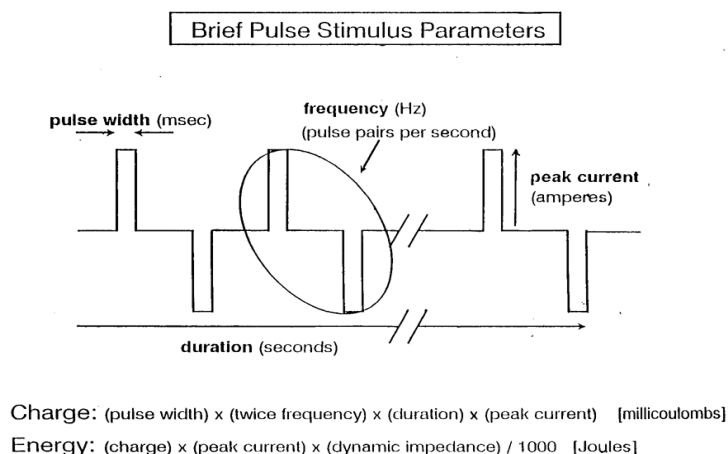

Figure 4.1. Description of wave parameters.

4.2 Materials and methods

4.2.1 Experimental animals

During this study all individual stunning measurements involving live animals were performed with approval of the ethical committee on animal experiments (DEC) of the Animal Sciences Group of Wageningen UR, in Lelystad. Batches of broilers from a commercial farm were transported to the experimental unit in Lelystad in crates (seven or eight per crate) and had been previously fasted for a period of at least six hours prior to delivery to the slaughterhouse.

Initially 24 broilers were used to determine the most promising waveform designs. Further investigation with the two most promising alternative waveforms was performed with an additional 24 broilers. In total, 48 broilers were used for this study.

4.2.2 Laboratory trials under controlled conditions.

All individual stunning experiments were performed as described previously in section 3.2. The EEG and ECG (section 3.2.3) were measured from 30 s prior to and up to 5 minutes after stunning. After bleeding the carcass of each bird was examined for signs of haemorrhaging or blood spots.

4.2.3 Waveforms

In an initial pilot 9 different waveforms were constructed using the available software for the waveform generator⁹.

Each wave was essentially an adaptation of the standard sine form shown in figure 4.2. The experimental designs were waveform variations designed to improve the efficacy of the electrical pulse in comparison to the effective root mean square efficacy seen with sinus waves, generally accepted to provide 75% of potential current. The modified square alternating current (AC) wave has been described in earlier work (figure 4.3; Lambooi et al, 2008a,b). This concept for the AC square wave was further developed to provide a design with a wave that was active (duty cycle; dc) for 43% of the duration of the signal (figure 4.3; Lambooi et al 2008a). A wave was designed to provide a further reduction in current capacity with a 32% dc in an attempt to reduce incidence of blood splashing while retaining an effective stun..

The experimental waveform designs are presented in figures 4.4 to 4.12.

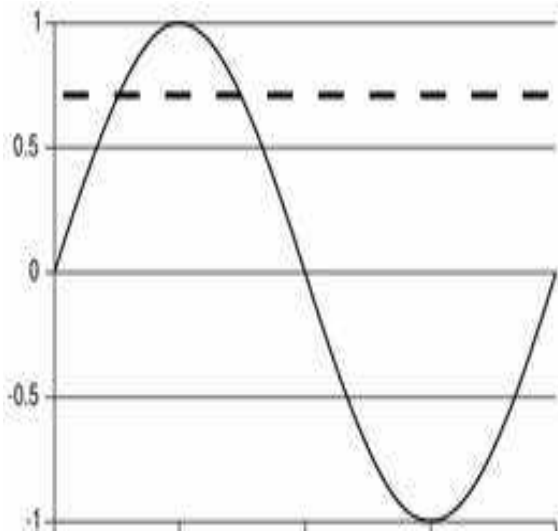

Figure 4.2. Standard sine wave (dashed line represents the root mean square value).

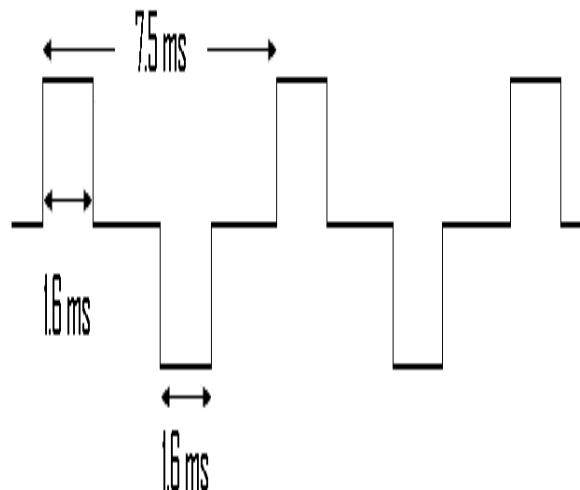

Figure 4.3. The modified square wave (Lambooi et al 2008 a, b).

⁹ Agilent 33220A, Agilent technologies inc., Santa Clara CA, USA

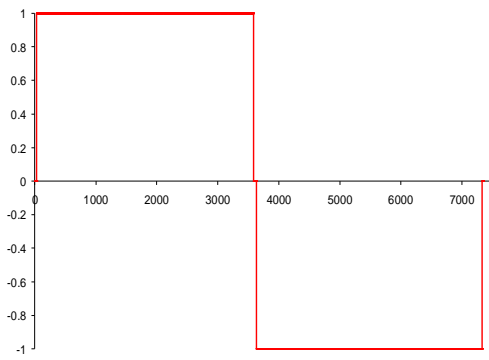

Figure 4.4: modified square AC waveform; Duty cycle (DC) = $\pm 100\%$; amplitude = 100%

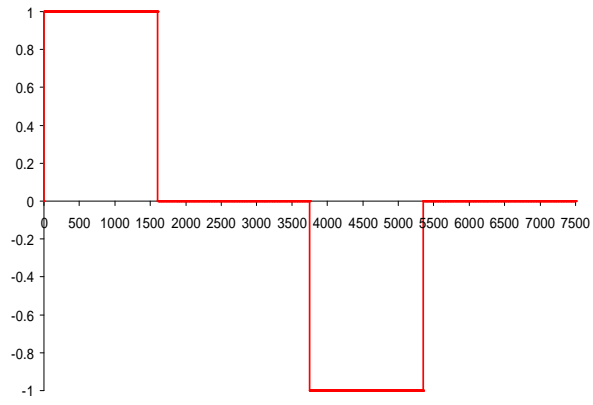

Figure 4.5; square AC waveform (“craft43%”), Duty cycle (DC)= 43%, amplitude = 100%.

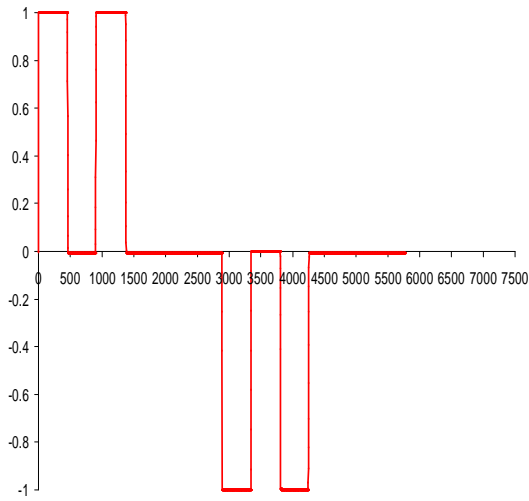

Figure 4.6 double square AC waveform (“wave 32”), DC = 32%, amplitude = 100%

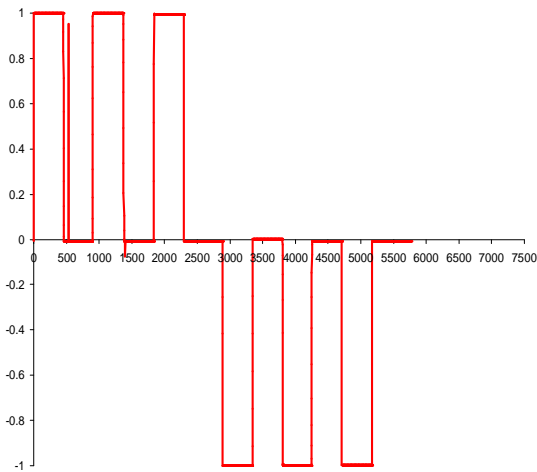

Figure 4.7 triple modified square AC waveform, DC = 50%, amplitude = 100%.

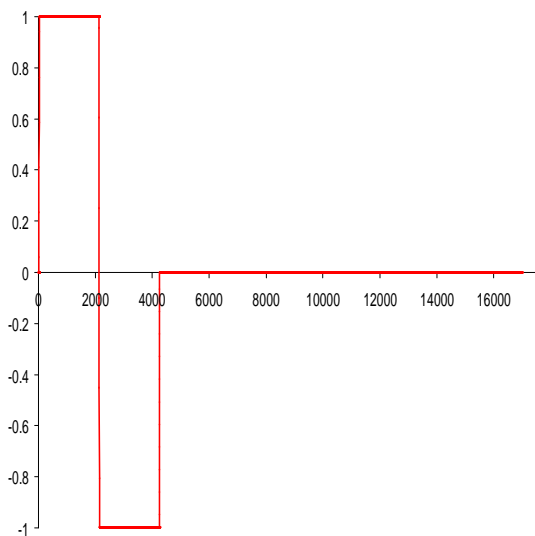

Figure 4.8: pulsed waveform (“Leonie”), (“Chaos”), amplitude =100%

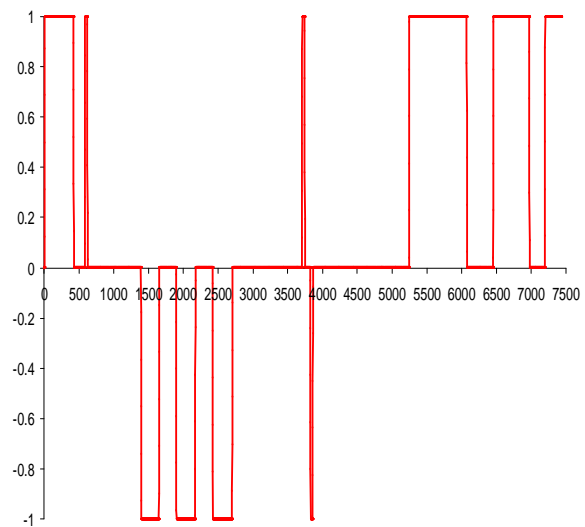

Figure 4.9: mixture of square waveforms DC = 25%, amplitude = 100%

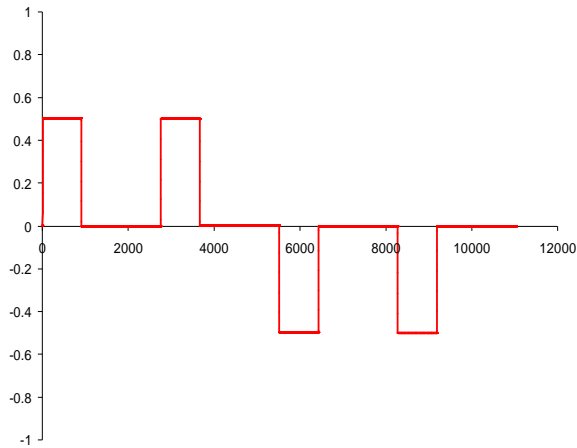

Figure 4.10: square AC waveform, DC = 32% , amplitude = 50%

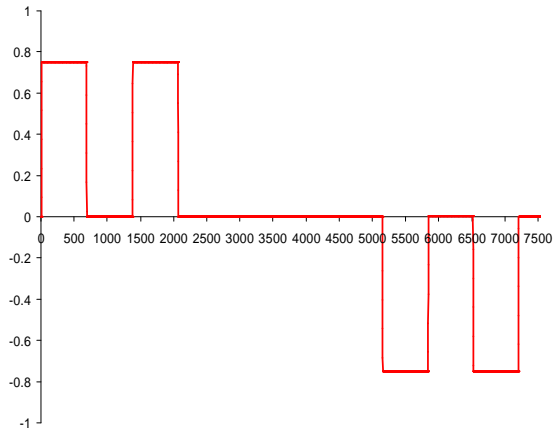

Figure 4.11 square waveform AC, DC= 32%, amplitude = 75%

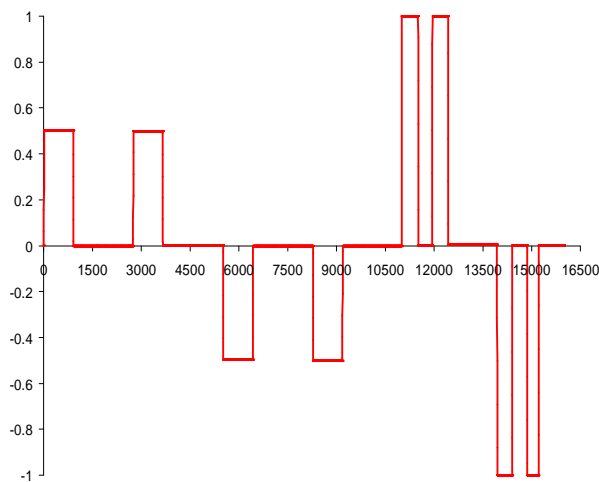

Figure 4.12: tandem square AC waveform, DC = 32% (50% amplitude + 100% amplitude)

The modified waveform consisted of a pulse width of 1.6 ms and a period length of 7.5 ms (Figure 4.3). A waveform involving a triple pulse with intermittent pauses with a 50% dc was also designed and tested (figure 4.7). A waveform was designed with combinations of pulses and longer duration (Figure 4.8). Alternatives to these were designed with varying amplitudes (Figure 4.9, 4.10 and 4.11) or in combination (figure 4.12).

Two waveforms with 43% and 32% dc were selected from the initial pilots as the most successful. All other waveforms were unsuccessful in producing adequate stuns. Further examination was performed under controlled conditions on individual broilers with the wave designs shown in figures 4.5 and 4.6.

4.3 Results.

The general epileptiform insult on the EEG was characterised by relative high frequent waves with high amplitude, which irregularly decreased in frequency and amplitude (tonic/clonic phase), followed by a period of strong depression of electrical activity (exhaustion phase).

Individual stuns were performed using waveform CRAFT43% (16 birds) or WAVE32% (8 birds). Differences in numbers presented in table 4.1 and 4.2 arise due to poor contacts or the fact that the 0.5 s stun was too short for registration with the oscilloscope. Therefore, due to the latter the results of two birds were discarded from set of measurements taken with the 0.5 s stun.

A half-second stun with the CRAFT43 wave was attempted on 16 broilers, 9 of which produced a general epileptic insult that on average lasted for 42 ± 20 s on the EEG. Average tonic phase lasted for 11 ± 4 s and the clonic phase lasted for 6 ± 2 s. the phase of exhaustion varied greatly lasting for 26 ± 20 s.

The average heart rate was 361 ± 147 beats/minute (bpm) prior to stunning. After stunning the ECG revealed fibrillation for 16 ± 4 s and became irregular afterwards. The mean (\pm S.D.) beats/min were 320 ± 72 , 390 ± 98 , 432 ± 88 , 423 ± 47 , 461 ± 41 , 444 ± 64 approximately 30 s, 1, 2, 3, 4 and 5 min after stunning.

Of the 8 half-second stuns attempted with WAVE32 only 3 resulted in successful insults. The average total duration of the insult was 26 ± 6 s on the EEG. After stunning the ECG revealed fibrillation for 14 ± 5 s and became irregular afterwards. Tonic phases of 7 ± 2 s, clonic phases of 8 ± 6 s and an exhaustion phase of 13 s (one broiler) were measured.

Average heart rate was available from 6 broilers stunned with the WAVE32 and averaged 385 ± 55 bpm prior to stunning. After stunning the ECG revealed fibrillation for 14 ± 5 s and became irregular afterwards. The mean (\pm S.D.) beats/min were 308 ± 102 , 373 ± 34 , 407 ± 45 , 412 ± 26 , 432 ± 37 , 412 ± 17 approximately 30 s, 1, 2, 3, 4 and 5 min after stunning respectively.

Longer stuns (5 seconds) were also attempted in order to demonstrate the potential for a stun to kill. The results varied considerably as shown in table 4.2.

A five second stun with CRAFT43 produced a responsive insult on the EEG for only 5 birds. On average the epileptic insult lasted for 36 ± 28 s, with the tonic phase lasting for 5 ± 2 s and the clonic phase for 8 ± 4 s, exhaustion varied considerably, lasting for 21 ± 26 s. Heart beat (ECG) measurements were obtained for 10 birds and prior to the stun was 425 ± 65 bpm. ECG revealed fibrillation for 11 ± 7 s and thereafter heart beat gradually recovered after 3 to 4 minutes. ECG readings disclosed averages of 289 ± 59 , 345 ± 76 , 382 ± 71 , 416 ± 70 , 247 ± 33 , 453 ± 49 for 30 s, 1, 2, 3, 4 and 5 minutes respectively.

Using WAVE32 for a 5 second stun resulted in 2 successful EEG measurements (insult of 8 and 15 seconds). Five ECG measurements were successful in displaying a heart beat of 410 ± 19 bpm prior to stunning, resulting in a fibrillation of 14 ± 9 s. Thereafter heart beat gradually recovered towards the level seen prior to stunning. ECG recordings were 208 ± 70 , 308 ± 42 , 380 ± 42 , 390 ± 69 , 430 ± 88 and 394 ± 70 bpm for 30 s, 1, 2, 3, 4 and 5 minutes respectively.

Table 4.1. Summary of measurements (RMS=root mean square; MAX=maximum voltage; P-P = voltage peak to peak;k Ω= impedance in Kilo-ohms) taken during electrical stunning of broilers for 0.5 s in a single bird water bath with voltage set at 122 V and frequency at 600 Hz.

	Voltage measured (mV)			Resistance ¹	Body weight
	RMS	MAX	P-P	kΩ	Kg
<u>CRAFT43% (fig.3.4)</u>					
Average	150.6	620	1302	1.61	2.4
Max	550	840	2560	2.77	2.9
Min	44	320	80	0.22	2.0
Sd	223.4	176.6	716.6	0.894	0.30
N ²	5	6	13	10	13
<u>WAVE32% (fig.3.5)</u>					
Average	424	728	1205	0.45	2.4
Max	633	1040	3080	1.15	2.8
Min	106	320	320	0.19	2.0
Sd	211.3	346.9	940.9	0.348	0.31
N ²	6	5	8	7	8

1 resistance calculated as output voltage (input used where reading for output is unavailable) divided by measured RMS current.

2. numbers differ due to amount of successful measurements taken.

Table 4.2. Summary of measurements (RMS=root mean square; MAX=maximum voltage; P-P = voltage peak to peak; k Ω = impedance in Kilo-ohms) taken during electrical stunning of broilers for 5 s in a single bird water bath with voltage set at 122 V and frequency at 600 Hz.

	Voltage measured (mV)			Resistance ¹	Body weight
	RMS	MAX	P-P	k Ω	Kg
CRAFT43% (fig. 4.5)					
Average	298	903	2083	0.99	2.4
Max	1040	2000	4040	2.65	2.9
Min	46	520	1120	0.12	2.1
Sd	301.4	497.9	1013.3	0.902	0.30
N ²	11	7	15	15	15
WAVE32% (fig.4.6)					
Average	605	2713	3400	0.20	2.4
Max	783	6920	7880	0.26	2.8
Min	470	120	1080	0.16	2.0
Sd	136.0	2882.5	2580.0	0.041	0.31
N ²	5	6	8	7	8

1 resistance calculated as output voltage (input used where reading for output is unavailable) divided by measured RMS current.

2. numbers differ due to amount of successful measurements taken.

Post mortem blood spots were observed in 81% (n=13) of the carcasses after stunning with CRAFT 43 and in 88% (n=7) after stunning with WAVE 32.

4.4 Conclusions.

Alternative wave forms may be effective to induce a general epileptiform insult (unconsciousness). However, due to the high currents blood splashes may occur. Therefore alternative waveforms are not recommended as a solution to the problem of blood splashing after water bath stunning.

5 Alternative routing of current application (head-to-cloaca).

5.1 Introduction

Essential to the success of electrical stunning of poultry are certain aspects including adequate contact between bird and electrodes, level of current administered, duration of the stun and reduction in impedance. A study was designed in continuation to an earlier pilot study performed using a specially designed penetrative or non-penetrative electrode (Lambooij et al, 2008b). This study was envisaged to distinguish alternative methods of improving the contact between bird and electrodes. It was hypothesized that the placement of electrodes in order to bypass the feet and legs would result in efficiency gains by utilizing lower currents. Additionally, use of alternatives waveforms to the standard sinus waveform could also improve efficient use of electricity. During this study the birds were restrained in a conventional shackle framework and individual stuns were performed using a non invasive double or single electrode placed on or in the proximity of the cloaca. A square AC wave (Lambooij et al, 2008 a,b) was used together with two new experimental wave designs described earlier (section 4). The effects on consciousness of combinations of current, voltage and frequency settings and an experimental waveform were evaluated using electroencephalography (EEG) and electrocardiography (ECG).

5.2 Materials and methods

5.2.1 Animals.

During this study all individual stunning measurements involving live animals were performed with approval of the ethical committee on animal experiments (DEC) of the Animal Sciences Group of Wageningen UR, in Lelystad. Broilers from a commercial farm that were destined for slaughter were transported to our experimental facilities in Lelystad. Head-to-cloaca stuns were performed on 27 broilers using the square AC wave ((Lambooij et al, 2008 a,b) and 5 broilers were stunned using one of the two alternative waveforms described earlier. The adapted placement of the electrodes is illustrated in Figure 5.1.

5.2.2 Procedure

Each bird was hung individually by the feet from the shackles and stunning was performed as the birds' head was immersed into a bath. The electrical current ran from head to rear of the bird. At the rear a double (n=27) or single (n=5) bar was lowered into position on to or in close proximity to the cloaca. These stainless steel bars formed the second electrode through which the electrical current passed from the bird. The water bath was raised so that the head was immersed and the bird was immediately stunned for 0.5 s (Figure 5.1). The experiments were performed as described earlier in section 3.2. The response of each animal to a pain stimulus (comb pinching) was observed for 5 minutes following the stun in order to assess unconsciousness. As described in section 3.2 the birds were stunned again and immediately (<20 seconds) bled by neck cutting. After bleeding for 2-3 minutes each bird was weighed and breast and leg muscles were examined for blood splashes. Heart and brain activity was monitored as described previously using ECG and EEG technology (section 3.2.3).

5.2.3 Waveforms

In addition to type and route of contact as represented by an adaption in electrode placement, different waveforms were used. A square AC wave (figure 4.4) was used (Lambooij et al 2008a,b). Thereafter, five measurements were performed using either the CRAFT (43% dc) or the WAVE (32% dc) described in section 4.

5.2.4 Statistical analyses.

Each bird represents an experiment with a probability P that the bird is unconscious during a general epileptiform insult. For n birds, which are treated independently, the number x, which are unconscious, is following a binomial distribution with total n and probability P. A confidence interval can be calculated for probability P based on a relationship between the binomial and beta distribution. The number of effective stuns follows a binomial distribution. A 95% confidence limit on the probability for an effective stun can be obtained by means of a well known relationship with the beta distribution (Johnson & Kotz, 1969).

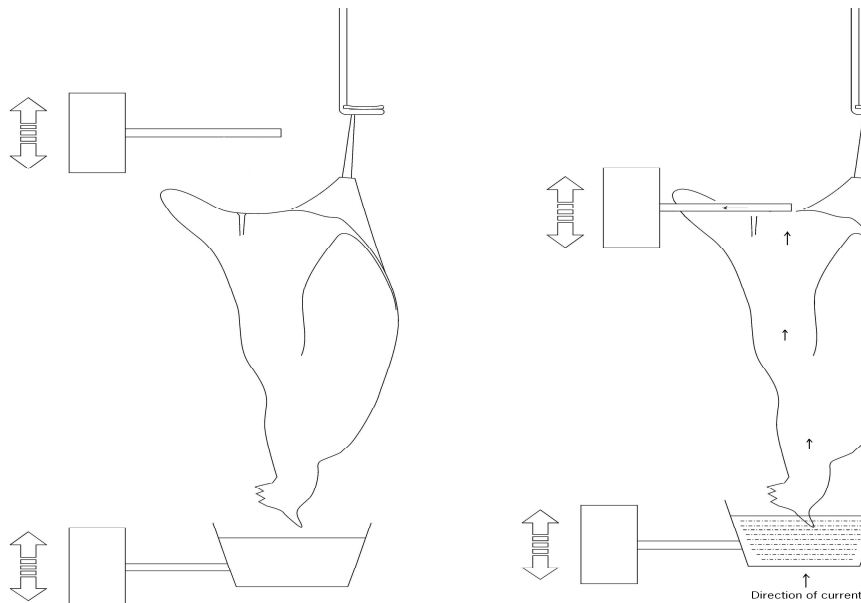

Figure 5.1 Schematic diagram of non-invasive head-to-cloaca stunner (Adapted from Lambooj et al. 2008b)

5.3 Results.

Measurements using a water bath and an electrode placed on the skin around the cloaca were performed with 32 broilers. On average the birds weighed 2.1 ± 0.4 kg. Initially, stuns were performed with a double bar electrode placed on either side of the cloaca. Usage of the double or single electrode did not appear to influence the results. Therefore, results of the measurements of electrical parameters (voltage, current, frequency, impedance) and body weight are summarized in table 5.1.

Of the 37 birds 25 were adequately stunned. A general epileptic insult was observed in 22 of the 25 broilers for which a successful EEG recording was obtained. The duration of the tonic/clonic phase as measured on the EEG was 14 ± 5 s where the exhaustion phase started at 27 ± 8 s and an iso electric line occurred and remained during the measuring period (Figure 5.2). Of the 15 birds that remained conscious after the stun 9 were given a stun at 53V or below. This voltage was obviously too low to generate sufficient current to induce a general epileptic insult (unconsciousness). Four stuns performed with alternative wave forms at 60 V (600Hz) or above were unsuccessful. Two animals stunned with the square AC wave at 100V (50Hz) did not lose consciousness (the reason for which remains unclear).

The average heart rate prior to stunning ($n=22$) was 369 ± 72 beats/min. After stunning the ECG revealed fibrillation for 14 ± 5 s ($n=22$).

Minimal blood splashes were observed in 18 out of 25 birds.

Within a confidence limit of 95%, taking into account the number of animals with a reliable EEG ($n=25$), the chance of an effective stun of all broilers is between 0.89 and 1.00 when a current of 111 ± 33 mA (54 V and 640 Hz, sinusoidal AC) is used.

Table 5.1: Results of head-to-cloaca 0.5 s stuns using a square AC wave (Lambooi et al 2008)

	Voltage RMS	Current RMS	Resistance	Body weight
	V	mA	k Ω	Kg
avg	105	89	1.30	2.2
max	125	212	1.74	2.8
min	98	61	0.61	1.5
sd	7	39	0.30	0.3
N ¹	13	13	13	13
CV%	6.3	43.1	22.92	15.13

N1 = Two if the 15 measurements were incomplete due to technical failures with oscilloscope.

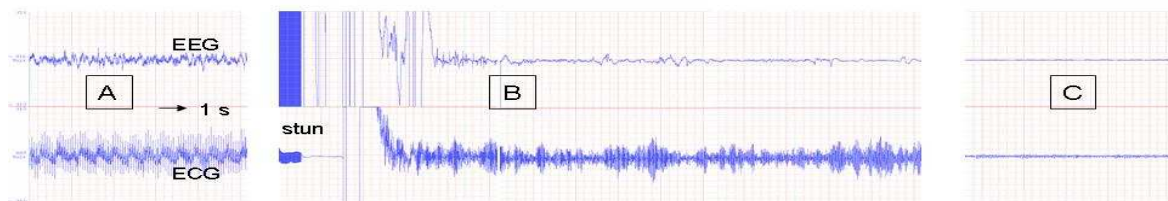

Figure 5.2: EEG and ECG before and after electrical stunning with the head to cloaca water bath stunner: A) Brain and heart activity immediately before stunning. B) Induced general epileptic insult which developed into an iso-electric line (EEG) due to the induced heart fibrillation (ECG) immediately after stunning. C) Both brain and heart activity cease approximately 444 ± 87 s after stunning.

After the 0.5 second stuns, a 3s stun was performed on 17 broilers, of which 6 were successful in producing a state of unconsciousness. Voltage varied between 50 and 130 V measured at frequencies 50, 300 or 600 Hz. Average current (RMS) was measured at 149 ± 32 mA for the 6 successful stuns. Average impedance was $0.5 \pm 0.15 \Omega$. Average body weight was 2.0 ± 0.5 kg. Heart rate prior to stunning was 405 ± 55 bpm which was slightly higher than prior to the 0.5 s stun. It should be mentioned that the 3s stuns were performed within 10 minutes after the original 0.5 s. The heart rate response to stunning (0.5 and 3 s) is summarized in figure 5.3.

Table 5.2: Results of head to cloaca stuns using a modified square AC wave with a 32% (section 4) or 43% duty cycle. (Lambooij et al., 2008a).

DC %	duration s	Freq. Hz	VOLTAGE		CURRENT Measured RMS	Resistance kΩ	Bodyweight kg
			Input Voltage	Output MAX RMS			
32	0.5	300	50	56	147	0.34	2.1
	3			56			
32	0.5	600	70	70	131	0.53	1.6
	3						
32	0.5	600	70	70	128	0.55	1.9
	3						
43	0.5	600	70	46	147	0.31	2
	3			45			
43	0.5	600	60	60	61	0.36	1.3
	3						

The 3 s stuns induced an insult lasting on average for 25±5 s. Heart fibrillation lasted for 10±2 s. On average heart beat showed signs of recovery between 1 to 2 minutes. Stuns were also performed using a modified AC wave with a 32% or 43% duty cycle, the electrical parameters measured during these stuns are presented in table 5.2. The EEG showed minimal brain activity (unconscious) which occurred after stunning and remained during the measuring period.

The average heart rate (figure 5.3) prior to stunning for successful stuns (n=4) was 365 ± 85 beats/min. After stunning the ECG revealed fibrillation for 11 ± 2 s and showed signs of recovery within 1 to 2 minutes. The mean (± S.D.) beats/min were 275 ± 44, 325 ± 51, 320 ± 70, 343 ± 116 (n=3), 395 (n=2), 420 (n=1) approximately 30 s, 1, 2, 3, 4 and 5 min after stunning.

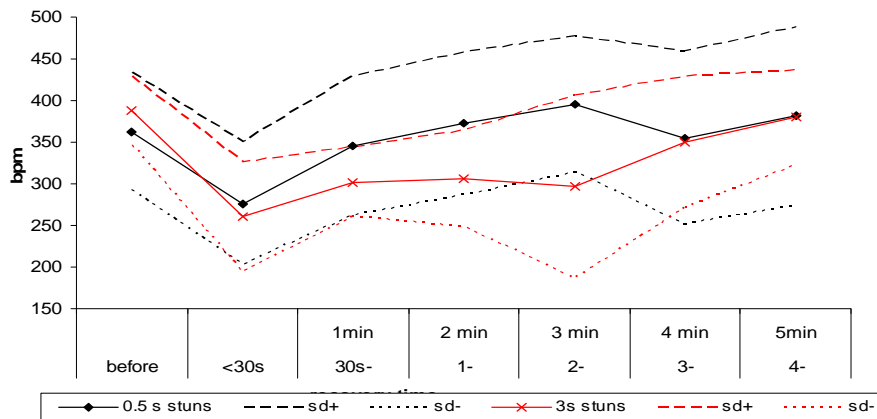

Figure 5.3 Heart rate response (bpm) during the stunning process (0.5 and 3s) and recovery period (max 5 mins) with head to cloaca electrodes.

5.4 Conclusions.

Broilers were effectively stunned with an average current of 111 mA (50 V; 640 Hz; sinusoidal AC) for 0.5 s using a water bath where the head of the broiler is immersed in water in contact with the positive electrode and a steel electrode positioned on or near the cloaca.

When a square wave pulsed alternating current 32% or 43% duty cycle is used the voltage and amperage required to induce unconsciousness could not be reduced.

6 An alternative to electrical stunning: Transcranial Magnetic Stimulation (TMS).

6.1 Introduction

In recent years there has been a continuous search for a painless method of stunning animals. Use of Transcranial Magnetic Stimulation (TMS) has been offered as one of the possible solutions to painless stunning. Magnetic seizure therapy was originally introduced in the therapeutic electric shock treatment of psychiatric and neurology patients during the 1980' s (Barker, 2002). TMS involves the creation of an electromagnetic field that induces an electrical current within the brain. The head is placed between or in close proximity to copper coils which can be built into a cap or pair of tongs. The brain acts as a conductor through which the current circulates and initiates a grand mal seizure. In practice, a large current is forced through the coil creating an electrical field which in turn generates a magnetic field that penetrates the surface of the brain lobe in close proximity to the coiled copper probe (George, 2003). Research with rabbits has shown that it is possible to render them unconscious using magnetic stimulation in this manner (Anil et al., 2000). The TMS device used during this study was patented and manufactured in England¹⁰.

6.2 Materials and method

6.2.1 Experimental animals.

During this study all individual stunning measurements involving live animals were performed with approval of the ethical committee on animal experiments (DEC) of the Animal Sciences Group of Wageningen UR, in Lelystad. Experiments were performed on 13 and 14 May 2008 at the poultry research facilities of the Animal Sciences Group of Wageningen UR in Lelystad, the Netherlands. During these two days 24 broilers (7 to 8 weeks old and weighing 3.5 ± 0.34 kg) were subjected to stunning using a prototype device capable of producing a magnetic stimulus to the brain.

6.2.2 Experimental procedure.

The device used (figure 6.1) is designed to deliver a magnetic stimulus to the brain induced via an electric current passing through a copper coil built in to a probe which is placed in close proximity to the brain. This was possible using a double probe placed over the skull (figure 6.2) or single probe placed on the rear of the skull (Figure 6.3).



Figure 6.1 TMS device

¹⁰ Magstim rapid, Spring Gardens, Withland, Carmarthenshire, Univ., Bristol, GB



Figure 6.2 Double coil



Figure 6.3 Single coil

6.2.3 Stimulator settings.

It was possible to adjust the amount of power generated by the device and the characteristics (frequency, duration of stun, number of pulses per second and the waiting time between cycles) of the impulse generated using a control panel on the stimulator (table 6.1, figure 6.4).



Figure 6.4 control panel TMS device.

All stuns lasted for five seconds. After each stun the broilers were observed for a maximum of five minutes to the response to a pain stimulus (comb pinch) (as described in section 3.2). Brain and heart activity were monitored using EEG and ECG measurements as described in section 3.2.3. The stimulator was set at 51 or 80% power for the single probe while one broiler was stunned at 100% power with the double probe. The higher the power setting the lower the frequency. Frequencies of 50 and 35 Hz were set at 51 and 80% power respectively. The power setting of 100% resulted in a frequency of 25 Hz. The number of pulses required per second was also adjustable and set within the range from 175 to 300 p/s.

6.2.4 Analysis of EEG signals.

The EEG traces were subjected to correlation dimension (CD) analysis. This analysis provides a non-linear (fractal) measure of signal complexity (for algorithm see Van den Broek et al., 2005). Correlation dimension analysis is a relatively new technique that has been customised to measure depth of anaesthesia in humans (Van den Broek, 2003, 2005). The small amplitude, high frequency (awake) EEG signal is more complex than the large amplitude, low frequency (unconscious) EEG signal. Therefore, high CD values are taken to indicate awareness while low values indicate a state of unconsciousness. Earlier studies with poultry (McKeegan et al, 2007) suggested that a reduction in CD to 60% of the baseline value seen in unconscious birds was an indicator of an unconsciousness level similar to anaesthetized humans.

6.3 Results

Table 6.1 shows an overview of the settings used in the 22 successfully completed stuns during the experiments (results from 2 birds omitted due to technical difficulties). The bodyweights of the broilers are also shown in table 6.1.

Use of the single probe resulted in 5 TMS stimulations that displayed sharp changes to theta and delta waves on the EEG. Four of the 6 birds reacted to a pain stimulus within 1 minute after completion of the stun, 3 of which recovered within 30 seconds. A fifth responded to the pain stimulus between 1-2 minutes. Eleven of the broilers stunned using the double probe responded to the pain stimulus within 1 minute (10 within 30 seconds). Three birds stunned using the double probe took between 1 -2 minutes to react to a pain stimulus. Two broilers failed to react to the pain stimulus within the allotted 5 minutes.

Table 6.1. Overview technical settings and body weight of broilers used during individual stuns using a TMS prototype.

Single coil						
	power	frequency	Duration	Number of pulses	Waiting Time (s)	weight kg
	%	Hz	s			
TMS03	51	50	5	250	86.1	3.5
TMS04	51	50	5	250	86.1	3.2
TMS06	51	50	5	250	86.1	na
TMS09	51	50	5	250	86.1	3.9
TMS13	80	35	5	250	86.1	3.2
TMS16	80	35	5	300	83.5	3.6
Double coil						
TMS01	51	50	5	250	86.1	3.3
TMS02	51	50	5	250	86.1	3.3
TMS05	51	50	5	250	86.1	3.7
TMS07	80	35	5	175	86.1	3.3
TMS12	80	35	5	250	86.1	4
TMS14	80	35	5	250	86.1	3.3
TMS15	100	25	5	250	86.1	3.8
TMS17	80	35	5	300	83.5	3.2
TMS18	51	50	5	300	83.5	3.6
TMS19	51	50	5	300	83.5	3.4
TMS20	51	50	5	300	83.5	3.8
TMS21	51	50	5	300	83.5	2.5
TMS22	51	50	5	300	83.5	3.5
TMS23	51	50	5	300	83.5	3.7
TMS24	51	50	5	300	83.5	4
TMS26	51	50	5	300	83.5	3.4

After analyses with the cordimanes analyzer the EEG's when using a single coil (Table 6.1) the birds displayed a sharp decrease in score which is an indication of unconsciousness and recovered gradually (Figure 6.1). When using the double coil and a power of 80% the birds became unconscious and drowsiness continued for the remainder of the measuring period (Figure 6.2). Drowsiness was also observed in their behaviour. Using a lower power of 51% the birds became unconscious, recovered slightly and became drowsy again (Figure 6.3).

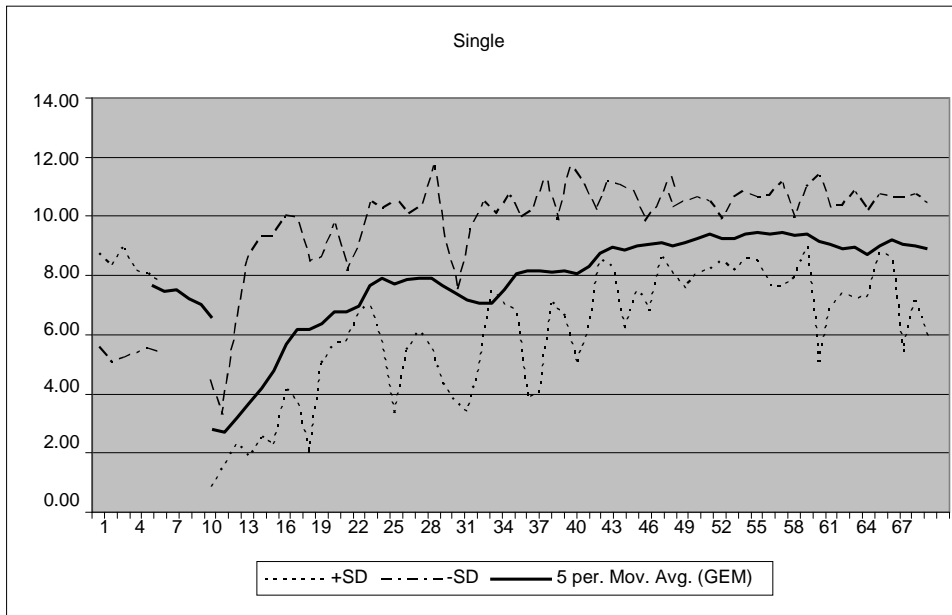

Figure 6.1 Correlation dimension analyses (Van den Broek, 2003) of EEG before and after TMS stunning using a single coil. The birds might be unconscious for approximately 15 to 20 s assuming that a reduction in CD to 60% of the baseline value indicates unconsciousness.

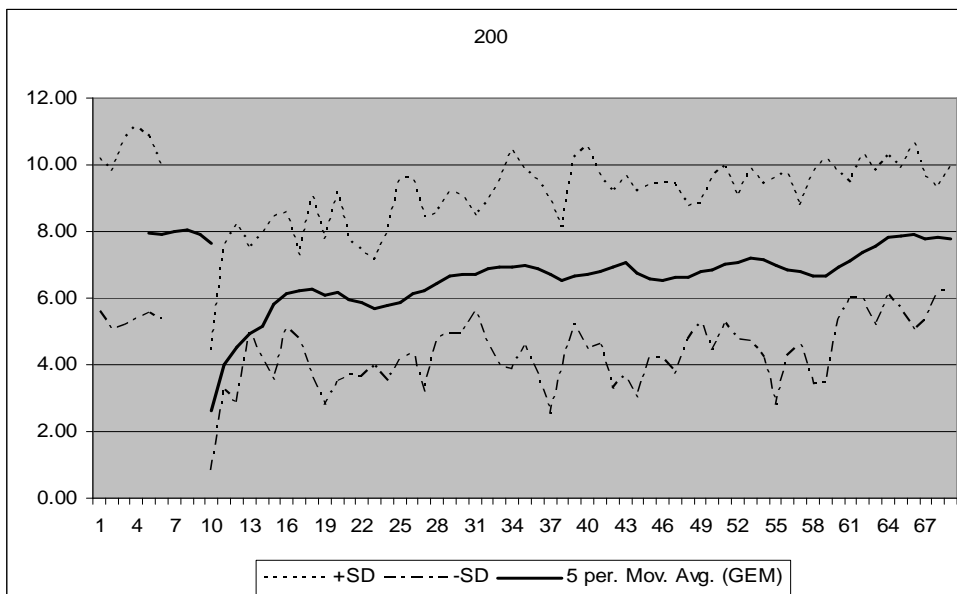

Figure 6.2 Correlation dimension analyses (Van den Broek, 2003) of EEG before and after TMS stunning using a double coil with a power of 80% . The birds might be unconscious for approximately 10 to 18 s assuming that a reduction in CD to 60% of the baseline value indicates unconsciousness but were drowsy thereafter.

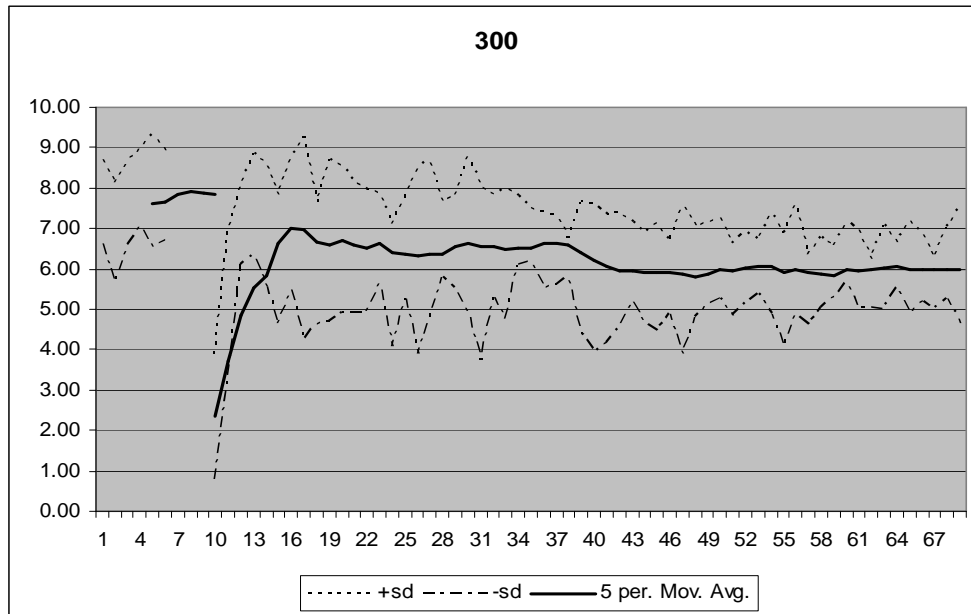

Figure 6.3 Correlation dimension analyses (van den Broek, 2003) of EEG before and after TMS stunning using a double coil with a power of 51 %. The birds might be unconscious for approximately 10-15 s assuming that a reduction in CD to 60% of the baseline value indicates unconsciousness but were drowsy afterwards.

Based on the assumption of earlier work (McKeegan et al 2007) in our study TMS induced a reduced state of consciousness for between 10-20 seconds irrespective the type of coil used. A reduction in the amount of power generated by the stimulator from 80 to 51% resulted in a reduction in duration of unconsciousness (10-15 s) thereafter all animals became drowsy and gradually regained consciousness.

6.4 Conclusions.

Transcranial magnetic stimulation (TMS) of the brain is a potential alternative for use as stunning method for broilers. However, more research is necessary to develop the method further for application as a stunning method.

7 The development of a stand alone in line measuring device

7.1 Introduction.

Accurate measurement of the electrical stunning method is often cause for concern to those wishing to determine how much energy is being supplied and exactly which levels of current are being administered to each bird. The amount of energy required for the water bath stunners in current usage remains uncertain due to difficulties in accurate measurement in the slaughter line (section 2). In an attempt to rectify this situation it was envisaged that a remote device could be hung in the slaughter line alongside the birds during a normal slaughter process (see figure 7.1 for a schematic drawing of such a device). This would be an ideal solution while minimizing the risks to personal safety. Such a “stand alone” device would have to be capable of registering the current, voltage and frequency of the energy source while passing through the water bath.

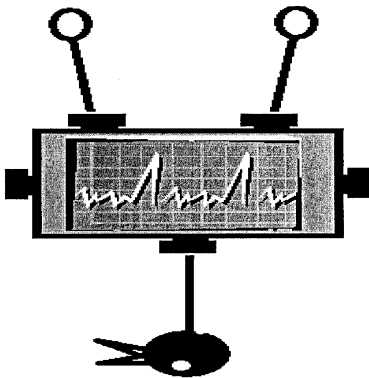

Figure 7.1 schematic drawing

7.2 Design

A prototype measuring device has been developed by RSP BV (Zoetermeer (NL)). Basically this device samples the current source repeatedly during a preset period (in this study set at 10 seconds). During this sampling period the device measures current voltage and frequency while also registering the waveform. Data from 7 sampling periods (runs) can be saved before the data has to be transferred to a PC or other data storage device. Before each run of 7 samplings the only variable to be adjusted is the resistance (impedance). The resistance to be set to an acceptable level representative to that expected from a living bird. The prototype provides the option for resistance settings from 500 – 3500 ohm. It is important to note that once set the resistance level remains at the level set for each run of 7 recordings.

7.3 Technical aspects.

The measuring device consists of a waterproof box (IP65). On the top two strong leads are attached to stainless steel bolts that are hung in the shackles to ensure a good contact with the stunning equipment. Underneath, a single lead protrudes from the box and is attached to a stainless steel weight that assures contact with the electrode in the water bath. This lead is adjustable in length to accommodate differing distances between shackle and water bath. The box contains a data logger, two 9-volt batteries and a connector for communication with a computer. The device is operated with a simple on/off switch and 3 LED's to indicate the strength of the battery and whether the apparatus is activated or in stand-by mode. Communication with the PC is facilitated via a separate built-in adaptor.

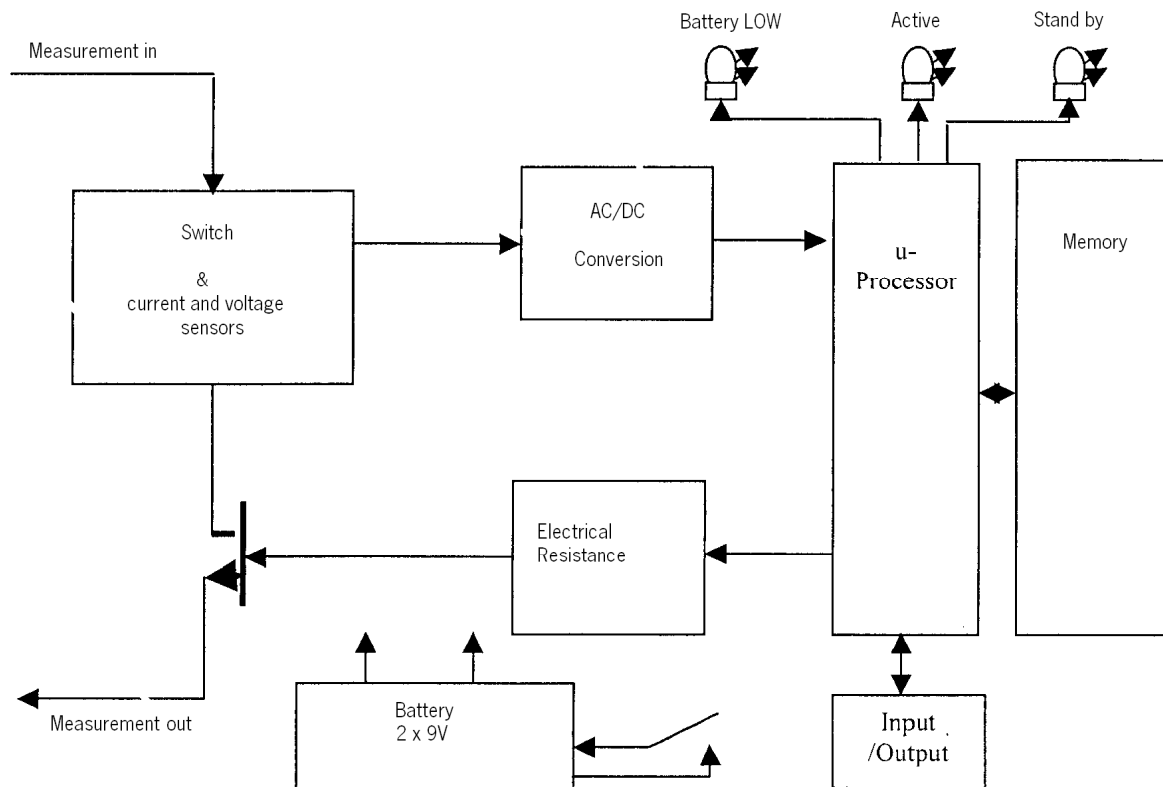

Figure 7.1 Scheme of device design.

When the measuring device is switched on it goes automatically into stand-by mode. Once in stand-by mode the device can be adjusted via the PC communication link. Resistance can be set at a required level and each series of measurements can be allocated a unique name allowing data recall after measurement. During this process the device does not record but checks the current level. Sampling and measurement can only begin when there is sufficient voltage (>20 V) and current (>10mA) available. Registration stops automatically when the current or voltage remains at zero for 5 seconds or longer or when the memory is full. The activity lamp glows during sampling and measurement.

Registered data measured during sampling can then be transferred to an excel file on the PC via RS 232. This worksheet contains data displayed as a graph (see figures 7.2, 7.3 and 7.4) with additional estimations for various parameters including frequency, peak values, effective values and impedance.

All the data are presented in a graphic form and several critical levels can be registered and stored until required for comparative purposes.

Since (relative to the required resistance) quite a large amount of power can be lost in the system, an internal temperature sensor has been included that can constantly monitor actual temperature. If the system temperature increases too high, the system closes down and the stand by lamp starts to flash until the temperature falls sufficiently. The critical temperature levels range between $T > 50$ (out) to $T < 30$ (in). A two-chip flash memory (2 x 64 Mb), assuming a unit sampling time (i.e. 6 sec per voltage sample and 6 μ sec per current sample) provides sufficient memory for 7 records of 10 seconds (sampling rate = 50.000 samples/sec) without having to reconnect to the PC.

Outlets:

- Serial port to PC RS232-115 kBaud
- Voltage sampling 0-150 V resolution 1 V.
- Current sampling 0-250 mA resolution 1 mA.

Inlets:

- Shackle contact leads 2 leads with RVS end pieces.
- Water bath contact lead 1 lead with RVS end piece.
- Adjustable resistance 500 – 3000 Ohm (scale divisions of 100 Ω).

Controls:

- On/off switch One contact
- Led battery LOW Yellow led that glows when battery is below 50% capacity.

Led stand by Green led when robot is switched on. Lamp flickers when power is LOW.
 Led active Red led which glows during active registration of data.
 Calibration accuracy:
 Measured at 20° C with 9 V battery.
 Voltage (absolute) ± 3 V (1.2% FS) 10 V < U < 250 V
 Current (absolute) ± 2.5 mA (1% FS) 10 mA < I < 250 mA.
 Resistance ± 50 Ohm (1.6% FS)
 Frequency ¹ ± 5 Hz (0.5% FS) U_{top} > 20 V and S/N ratio > 30 dB
 1) Frequency determination based on filtering of zero responses. If shackles shake then risk of false zero's increases with detrimental affect on estimation of frequency.

7.4 Results

See for the results from evaluation in slaughterhouses section 2 (table 2.1).

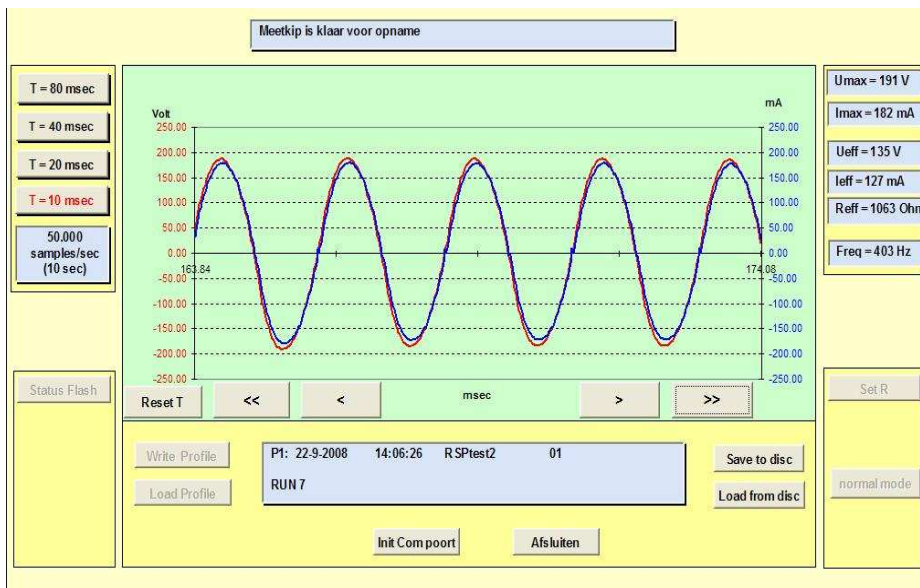

Figure 7.2 Example of read out display from in line measuring device. Electrical impedance preset to 1000 ohm. For a sinus wave delivered at 400 Hz.

A typical read out display from the stand alone device is shown in figures 7.2 to 7.4 from a pilot measurement performed in our laboratory in an individual water bath. In this example the impedance has been set at 1000 ohm (figure 7.2) and a sinus wave was used to administer approximately 135 effective V (RMS), Frequency was set at 400Hz. It is generally considered that 1000 ohm is the average impedance level encountered with broilers. But as seen during experiments performed in our laboratory electrical impedance of broilers can vary from 0,8 -3.9 kΩ .

Readings are taken at a rate of 50.000/ second and can be displayed as 10 msec samples (as in figure 7.2) or at 20, 40 or 80 msec samples. This display gives the means for maximum and effective (RMS) voltage and currents for the period required.

Figures 7.3 and 7.4 show the effect on the effective current (RMS) which falls from 127 mA at 1000 ohm (figure 7.2), to 86mA at 1500 ohm (figure 7.3) and is reduced even further to 51mA at 2500 ohm (figure 7.4). This range in impedance was observed during our investigation of the current situation in Dutch slaughterhouses.

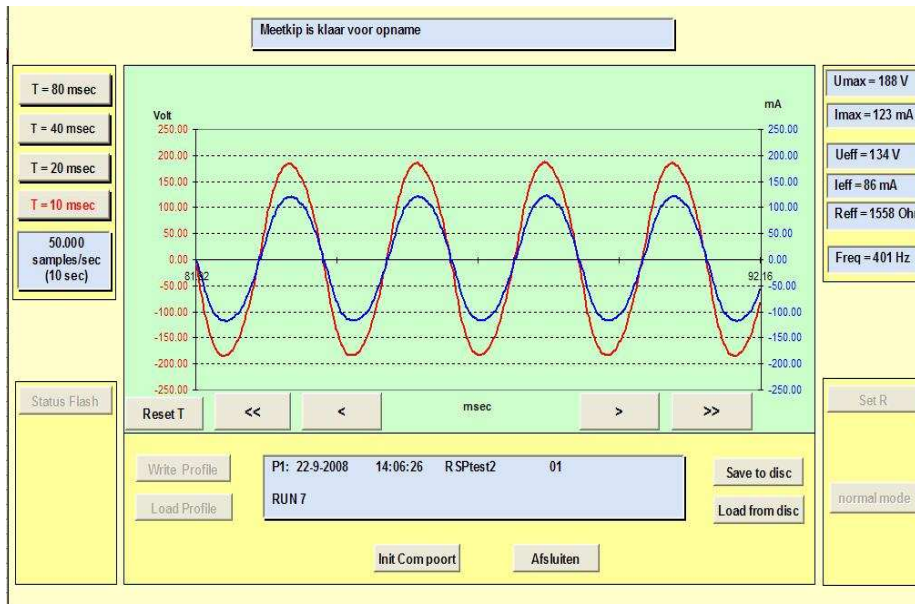

Figure 7.3 example of read out display from in line measuring device. Electrical impedance preset to 1500 ohm. For a sinus wave delivered at 400 Hz.

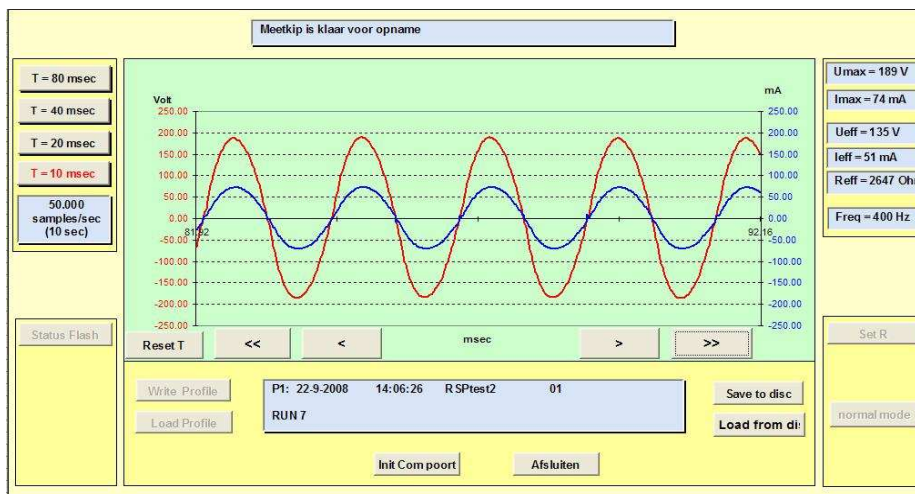

Figure 7.4 example of read out display from in line measuring device. Electrical impedance preset to 2500 ohm. For a sinus wave delivered at 400 Hz.

Although the prototype has been shown to be capable of in line measurement (section 2) certain aspects have to be improved before practical application is possible.

Further development of the two prototypes is ongoing to improve technical measurement, duration of measurement, application and data storage software and general user friendliness as this device is intended for use by the controlling authorities. This device will be used for individual monitoring in of voltage, current, frequency and impedance under slaughterhouse conditions and therefore will require further intensive testing of durability, accuracy and adaptation prior to implementation.

7.5 Conclusions.

It has been demonstrated that this device is capable of taking measurements under practical conditions. This device is a valuable application to aid competent measurement and management in slaughterhouses.

8 Conclusions

Large differences were observed between slaughterhouses in the settings for water bath stunning parameters for broilers, hens and ducks. These differences were seen with regard to the varying numbers of birds present in the water bath, variation in stunning duration, voltage (V) and frequency (Hz) levels applied.

Based on the observed differences in technical settings (V, Hz), and between-animal differences in impedance and between-animal differences in sensitivity, it is highly probable that large numbers of birds are inadequately stunned during current usage of the water bath technique in slaughterhouses.

Large differences were measured in the strength of current (mA) applied to each bird. At the same voltage settings this implies large differences in electrical impedance between individual birds within and between groups.

Under present conditions in practice it is impossible to measure exactly the level of current (mA) each bird receives during water bath stunning.

In-line measurement is an essential aid in order to provide an adequate and objective evaluation of current water bath stunning in Dutch slaughterhouses. The prototype device developed in this study measured voltage (V), current (mA) and frequency (Hz). The prototype measuring device has shown its potential but should be developed further before it can be accepted for practical application..

Use of a wave frequency of 50Hz applied for 5s and delivering a current of 100 mA produces an effective stun in most birds. Applications using higher frequencies require higher levels of current (mA) to produce effective stuns. Present legislation (100 mA irrespective wave frequency) is inaccurate because it does not account for frequency and other wave characteristics (i.e. amplitude, duty cycle and waveform)..

Effective electrical stunning causes blood splashing in muscle tissue, also at higher frequencies.

Alternative waveforms with differing duty cycles (active period) are capable of inducing an effective stun with broilers. However, shorter duty cycles require higher levels of current to produce an effective stun. These higher currents also result in blood spots. Alternative waveforms do not lead to more effective stunning. Therefore, application of alternative waveforms for water bath stunning do not provide an improvement as compared to conventional waveforms.

Alternative positioning of the electrode onto the cloacal region of the bird, instead of the conventional method via the feet and legs, reduced the current level required at a higher frequency for an effective stun.

Transcranial magnetic stimulation (TMS) is a potential alternative for use as stunning method for broilers that should be developed further.

Conclusies

Er zijn grote verschillen tussen de Nederlandse slachterijen (vleeskuikens, leghennen en eenden) in toepassing van elektrische waterbad verdoovers. Deze verschillen betreffen het aantal dieren dat tegelijk in het waterbad gaat, de verdovingsduur, de toegepaste spanning (V), de stroomsterkte (mA) en frequentie (Hz).

Op basis van de gemeten praktijk instellingen (V, Hz), de verschillen in elektrische weerstand tussen dieren en het verschil in gevoeligheid tussen dieren onderling is het zeer aannemelijk dat onder de huidige praktijk omstandigheden een aanzienlijk deel van de dieren niet voldoende wordt bedwelmd in het elektrische waterbad.

Er zijn grote verschillen gemeten in gerealiseerde stroomsterkte (mA) per individueel dier. Bij gelijk (ingesteld) spanningsverschil duidt dit op grote verschillen in elektrische weerstand tussen dieren zowel binnen een koppel als tussen koppels.

Onder de huidige praktijkomstandigheden kan niet voor elk individueel dier worden vastgesteld welke stroomsterkte is gerealiseerd.

Voor een adequate en objectieve beoordeling van elektrische verdoovers in slachterijen is een in-line meetmodule noodzakelijk. Deze meetmodule registreert voltage, stroomsterkte en frequentie. De in dit onderzoek ontwikkelde concept meetmodule is hiervoor een bruikbare methode maar verdere aanpassing voor praktijktoepassing op grotere schaal is nodig.

Bij een toegepaste frequentie van 50Hz wordt voor de meeste dieren een effectieve verdoving bereikt bij 100mA bij een stroomstoot van 5s. Bij het toepassen van hogere frequenties zijn hogere stroomsterktes nodig om een effectieve bedwelming te realiseren. De huidige wetgeving (100mA ongeacht frequentie) voldoet daarom niet en zou ook rekening moeten houden met de toegepaste frequentie en andere karakteristieken (b.v. amplitude en golfvorm)

Effectieve elektrische bedwelming is sterk positief gecorreleerd met het optreden van spierbloedingen, ook bij hogere frequenties. Het is duidelijk dat alternatieve golfvormen met een verschillende 'duty cycle' (effectieve periode) een effectieve verdoving kunnen induceren. Kortere 'duty cycles' vereisen echter hogere effectieve stroomsterktes om te komen tot effectieve verdoving. De hogere stroomsterktes leiden ook hier tot spierbloedingen. Het toepassen van alternatieve golfvormen bij de elektrische waterbad verdoving geeft dan ook geen verbetering ten opzichte van de huidige standaard golfvorm.

Het toepassen van een alternatieve stroomroute zoals kop-cloaca in plaats van de conventionele stroomroute door de voeten en poten geeft een aanzienlijke reductie in benodigde stroomsterkte om te komen tot een effectieve verdoving

Transcraniale Magnetische Stimulatie (TMS) is in potentie een alternatief voor de conventionele stroombronnen. Een verdere ontwikkeling van de methode is noodzakelijk om in de praktijk toegepast te kunnen worden.

9 Recommendations

Present legal standards for electrical stunning of poultry must be adapted to include specification of frequency and duty cycle.

Measurement of the application settings in practice must be performed in line at animal level. Further development of the prototype in line measuring device is essential to monitor application settings under practical conditions.

Use of the conventional electrical water bath in its present form is to be strongly discouraged because of the inability to guarantee that each bird receives sufficient current for an effective stun..

The following important aspects should be developed further for practical application:

- Alternative pathways for application of stunning;
- Individual application of an electrical stun;
- Alternative electrical stunning methods;
- Improved methods of restraining birds during stunning.

Aanbevelingen

De huidige wettelijk norm voor het elektrisch verdoven moet worden aangepast waarbij rekening gehouden moet worden met de stroomfrequentie en 'duty cycle' (effectieve periode).

Monitoren van de toegepaste instelling in de praktijk moet aan de slachtlijn op dierniveau plaats vinden. Het praktijkrijp maken van de hier ontwikkelde en gebruikte meetmodule is hiervoor noodzakelijk.

Het gebruik van het elektrische waterbad in de huidige vorm en toepassing dient ontmoedigd te worden omdat niet gegarandeerd kan worden dat alle dieren voldoende stroom toegediend krijgen.

De volgende aspecten, die van belang zijn voor het correct bedwelmen van pluimvee, dienen verder te worden ontwikkeld voor toepassing in de praktijk:

- Ontwikkelen van alternatieve stroomroutes;
- Individuele toediening van elektrische stroom;
- Ontwikkelen van alternatieve stimulatie methoden van de hersenen (opwekken bewusteloosheid);
- Ontwikkelen van een betere manier van fixatie van het dier tijdens het bedwelmen.

Literature

- Anil, M. H., Butler, S.R., Johnson C.B. and McKinstry J.L. (2000): Suppression of somatosensory evoked potentials by transcranial magnetic stimulation in the rabbit. *Proceeding Physiological Society*, 526P.
- Barker, A.T. (2002): The history and basic principles of magnetic nerve stimulation. In: Eds: Pascual-Leone, A., Devey, N.J., Rothwell, J., Wassermann, E.M., Puri, B.K. "Handbook of Transcranial Magnetic Stimulation. Arnold. London. PP 2-17
- Bilgili, S.F., 1999. Recent advances in electrical stunning. *Poultry Science*, 78: 282-286.
- European Food Safety Authority (EFSA), 2004. AHAW/04-027. Welfare aspects of stunning and killing methods.
- Broek, P.L.C. van den, 2003. Monitoring anaesthetic depth. Modification, evaluation and application of the correlation dimension. PhD Thesis Nijmegen University Press The Netherlands.
- Broek, P.L.C., van den, J. van Egmond, C.M. van Rijn, F. Takens, A.M.L. Coenen and L.H.D.J. Booij. 2005. Feasibility of real-time calculation of correlation integral derived statistics applied to EEG time series. *Physica D* 203: 198-208.
- European Food Safety Authority (EFSA), 2006. Annex to the EFSA journal (2006) 326, 1-18. The welfare aspects of the main systems of stunning and killing applied to commercially farmed deer, goats, rabbits, ostriches, ducks, geese and quail.
- George, M.S., 2003. Stimulating the brain. *Scientific American*. 47-53. www.sciam.com
- Gregory, N.G. and L.J. Wilkins. 1989. Effect of stunning current on carcass quality in chickens. *Vet. Rec.* 124:530-532.
- Gregory, N.G. and S.B. Wotton. 1990. Effect of stunning on spontaneous physical activity and evoked activity in the brain. *Br. Poult. Sci.* 31:215-220.
- Genstat, 2008. GenStat Release 11.1 (PC/Windows). VSN international Ltd.
- Johnson, N.L., S. Kotz, 1969. Discrete distributions. John Wiley, New York.
- Kranen, R.W. 1999. Hemorrhages in muscles of broiler chickens. PhD thesis Catholic Univ. Nijmegen.
- Lambooi, E., M.A. Gerritzen, H. Reimert, D. Burggraaf and J.W. van de Vis. 2008a. A humane protocol for electro-stunning and killing of Nile tilapia in fresh water. *Aquaculture* 275:88-95.
- Lambooi, E., H. Reimert, J.W. van de Vis and M.A. Gerritzen. 2008b. Head-to-cloaca electrical stunning of broilers. *Poult. Sci.* 87:2160-2165.
- McKeegan, D.E.F., J.A. McIntyre, T.G.M. Demmers, J.C. Lowe, C.M. Wathes, P.L.C. van den Broek, A.M.L. Coenen and M.J. Gentle. 2007. Physiological and behavioural responses of broilers to controlled atmosphere stunning: implications for welfare. *Animal welfare*, 16:409-426.
- Raj, A.B.M. 2006. Recent developments in stunning and slaughter of poultry. *World's Poultry Science Journal*, 62:467-484.
- Saverijne, B., E. Lambooi, C. Pieterse and J. Korf. 2000. Electrical stunning and exsanguination decrease the extracellular volume of the brain, as studied with brain impedance recordings. *Poult. Sci.* 79:1062-1066.
- Veerkamp, C.H. and A.W. de Vries. 1983. Influence of electrical stunning on quality of broilers. Pages 197-207 in *Stunning of animals for slaughter*. G. Eikelenboom, ed. Martinus Nijhoff, The Hague, the Netherlands.
- Woolley, S.C., F.J.W. Borthwick and M.J. Gentle. 1986a. Tissue resistivities and current pathways and their importance in pre-slaughter stunning of chickens. *Br. Poult. Sci.* 27:301-306.
- Woolley, S.C., F.J.W. Borthwick and M.J. Gentle. 1986b. Flow routes of electric currents in domestic hens during pre-slaughter stunning. *Br. Poult. Sci.* 27:403-408.